

Thinking of you

 **Electrolux**

EXP12EN1WI

EN PORTABLE AIR
CONDITIONER

USER MANUAL



Electrolux. Thinking of you.

Share more of our thinking at www.electrolux.com

CONTENTS

Safety information	2	Operating instructions	10
Product description	4	Care and cleaning	12
Accessories	4	What to do if...	13
Installation	5	Environment concerns	14
Control panel	9		

Subject to change without notice.

SAFETY INFORMATION

Before use, carefully read the supplied instructions. The manufacturer is not responsible if incorrect use causes injuries and damages. Always keep the instructions for future reference.

- Do not install the appliance where there is direct sunlight.
- Be careful, when adjusting the horizontal louvres. There is a risk of catching fingers on the fan.

CHILDREN AND VULNERABLE PEOPLE SAFETY

 **Warning!** Risk of suffocation, injury or permanent disability.

- Do not let persons, children included, with reduced physical sensory, reduced mental functions or lack of experience and knowledge use the appliance. They must have supervision or instruction for the operation of the appliance by a person who is responsible for their safety.
- Do not let children play with the appliance.
- Keep all packaging away from children.

INSTALLATION

 **Warning!** Risk of overheating, fire or damage to the appliance.

- Only a qualified person must install this appliance.
- The installation must be performed in accordance to the national wiring standards (if applicable).
- Move or store the appliance in an upright position.
- Remove all the packaging.
- Do not install or use a damaged appliance.
- Do not install or use the appliance where the temperature is less than 0 °C.
- Obey the installation instruction supplied with the appliance.

Electrical connection

 **Warning!** Risk of fire and electrical shock.

- Make sure the appliance is installed correctly. Loose and incorrect plug and socket connections can make the terminal become too hot.
- Always use a correctly installed shock-proof socket.
- Do not use multi-plug adapters and extension cables.
- Make sure not to cause damage to the electrical components. Contact the Service or an electrician to change the electrical components.
- The power cord must not touch hot surfaces of other appliances.
- Do not use the power cord near flammable gas or combustibles, such as gasoline, benzene, thinner, etc.
- Always install circuit breaker and a dedicated power circuit.
- Connect the mains plug to the mains socket only at the end of the installation. Make sure that there is access to the mains plug after the installation.
- Do not pull the mains cable to disconnect the appliance. Always pull the mains plug.
- Provide a residual current device (RCD).
- Make sure the power supply has an appropriate voltage rating. Only use 220V

— 240V, 50Hz, 10A mains electricity supply.

- The appliance must be earthed.
- The appliance is equipped with a cord having an earth wire connected to a grounding tab (**A**). The plug must be plugged into an outlet that is properly installed and earthed.

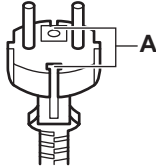

- **ONLY FOR UK:** The appliance is equipped with a cord that has an earthed wire connected to an earthed pin (**B**). The plug must be plugged into a socket that is properly installed and earthed. Do not under any circumstances cut or remove the square earthed pin (**B**) from the plug.

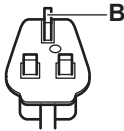

USE

 **Warning!** Risk of injury, burns, electrical shock or fire.

- Use this appliance in a household environment.
- Do not change the specification of this appliance.
- Do not direct the airflow at room occupants, pets or hose plants.
- Ventilate the room before using the air conditioner.
- Do not operate the appliance with wet hands or when it has contact with water.
- Do not operate the appliance without the air filter.

- Always drain the condensate before storing the appliance.
- Make sure the drain hose is not above the drain fitting.
- Do not place obstacles around the air-inlets or inside of air-outlets.
- Do not operate or stop the appliance by pulling out the power cord.
- Do not operate the appliance near any heat source or open fire.
- Do not cover the appliance when in operation or immediately after use.
- Do not drink water drained from the appliance.
- If a burning smell or any other abnormality occurs, deactivate the appliance immediately.

CARE AND CLEANING

 **Warning!** Risk of injury or damage to the appliance.

- Contact Service for maintenance or repair of this appliance.
- Deactivate the appliance before cleaning.
- Before maintenance, deactivate the appliance and disconnect the mains plug from the mains socket.
- When the air filter is to be removed, do not touch the metal parts of this appliance.
- Clean the filter once every two weeks. Always insert the filters securely.
- Do not use water spray and steam to clean the appliance.
- Clean the appliance with a moist soft cloth. Only use neutral detergents. Do not use abrasive products, abrasive cleaning pads, solvents or metal objects.

DISPOSAL

- Disconnect the appliance from the mains supply.
- Cut off the mains cable and discard it.
- This appliance uses R410A refrigerant.
- If you wish to discard this product, please contact your local authorities and ask for the correct method of disposal.

PRODUCT DESCRIPTION

UNIT DESCRIPTION

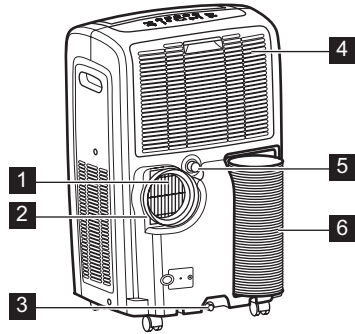
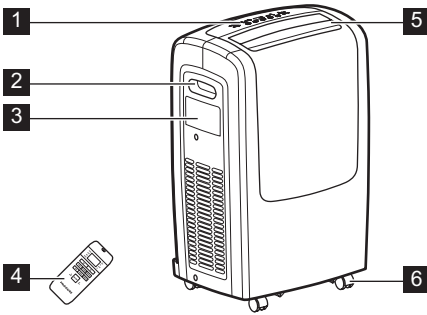

- 1** CONTROL PANEL
- 2** CARRYING HANDLE (BOTH SIDES)
- 3** REMOTE CONTROL STORAGE DOOR
- 4** REMOTE CONTROL
- 5** ROOM AIR DISCHARGE
- 6** CASTOR

- 1** EXHAUST AIR OUTLET
- 2** EXHAUST ADAPTOR A
- 3** BOTTOM TRAY DRAIN OUTLET
- 4** AIR INTAKE
- 5** DEHUMIDIFYING DRAIN OUTLET
- 6** EXHAUST HOSE (STORAGE WHEN NOT IN USE)

ACCESSORIES

i Check all the accessories are included in the package and please refer to the "Installation" chapter for their usage.

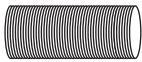

A



B



C

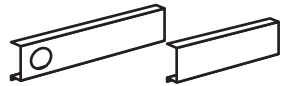

D



E

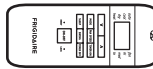

F

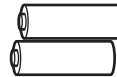

G



H



I



J

PART	PART NAME	QUANTITY
A	Exhaust hose	1 pc
B	Unit/Exhaust Adaptor A	1 pc

PART	PART NAME	QUANTITY
C	Window/Exhaust Adaptor B	1 pc
D	Window Sliding Kit	1 pc
E	Foam Seal	3 pc
F	Remote Control	1 pc
G	Battery (for remote control)	2 pc
H	Wall Adaptor (for permanent duct mounting)	1 pc
I	Wall Plug	4 pc
J	Screws	4 pc

INSTALLATION

EXHAUSTING HOT AIR WINDOW DISCHARGE

In the COOLING mode (COOL) the appliance must be placed close to a window so that the warm exhaust air can be ducted outside. First, place the unit on a flat floor and make sure there's a minimum of 30,5 cm clearance around the unit, and is within the vicinity of a single circuit outlet power source.

1. Take the hose out from back of the unit

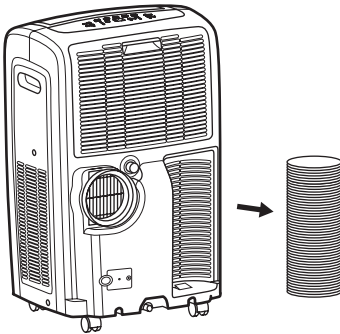

2. Remove adaptor A from units by sliding sideways.

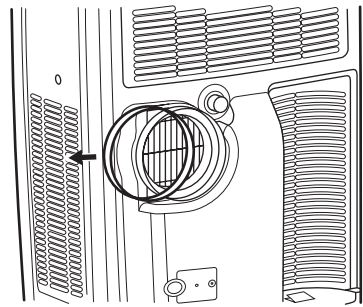

3. Extend either side of the hose and screw the hose to adaptor A.

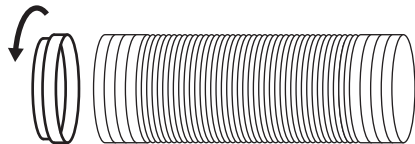
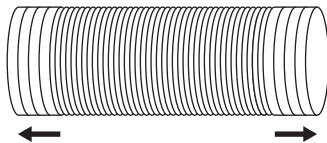

4. Extend the other side of the hose and screw it to adaptor B.

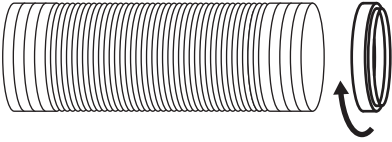

5. Slide the assembly onto unit.

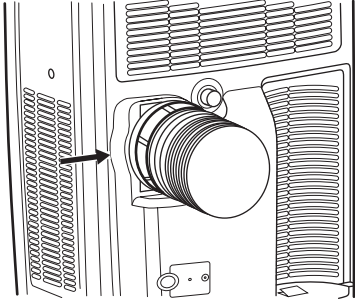

6. Affix the adaptor B into the window slider kit and seal.
- Window slider kit:
Minimum: 67,5 cm (26,6 inches)
Maximum: 123 cm (48,5 inches)

Vertical window

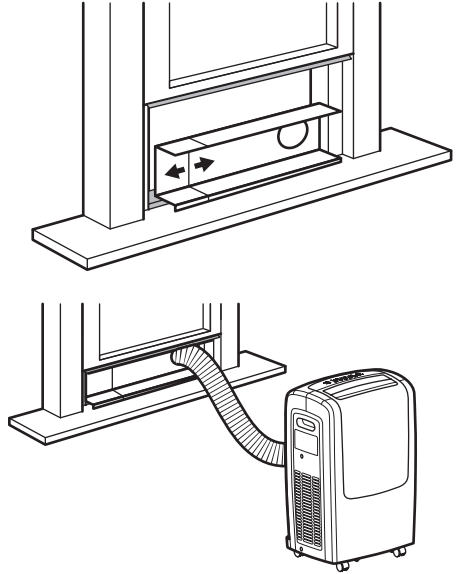

Horizontal window

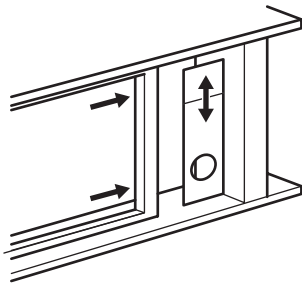

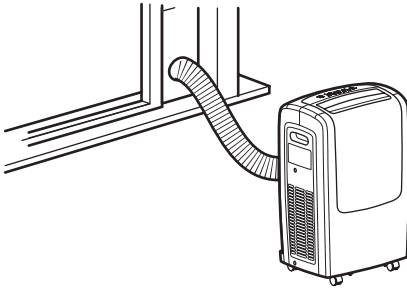

WALL DISCHARGE

Mount wall adaptor directly over correctly installed duct to outside. (This usually includes aluminium wall ducting and an outside cover. See your hardware specialist for correct installation.)

Use wall plugs and screws to secure. Attach hose duct to wall adaptor.

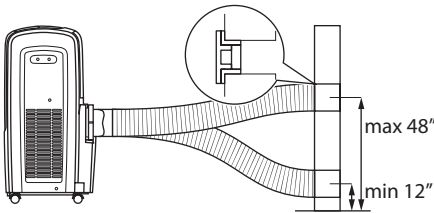

The hose can be extended from its original length of 38,1 cm up to 139,7 cm, but it is the best to keep the length to minimum required. Also make sure that the hose does not have any sharp bends or sags.

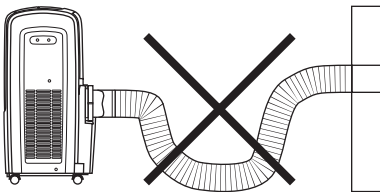

INSTALLATION IN A DOUBLE-HUNG SASH WINDOW

1. Cut the foam seals - adhesive type **(A)** to the proper lengths and attach them to the window and stool.

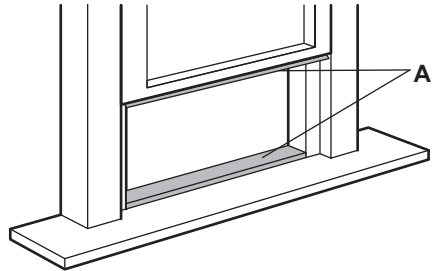

2. Attach the window slider kit to the window stool. Adjust the length of the window slider kit according to the width of window. Cut the adjustable window slider kit if the width of window is less than 67,5 cm.

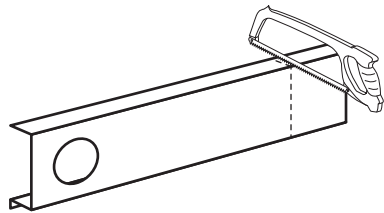

3. Open the window sash and place the window slider kit **(B)** on the window stool **(C)**.

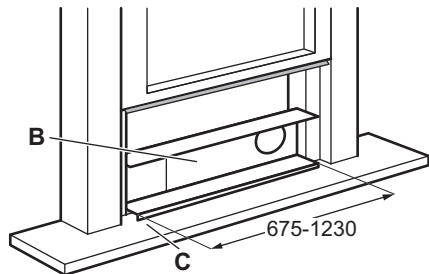

4. Close the window sash securely against the window slider kit.

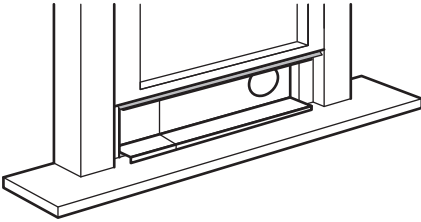

3. Open the window sash and place the window slider kit (B) on the window stool (C).

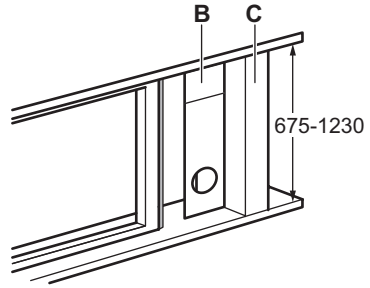

5. Cut the foam seals to an appropriate length and seal the open gap between the top window sash and outer window sash, as shown.

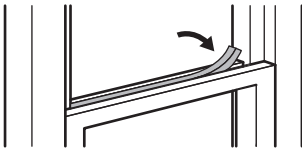

4. Close the sliding sash securely against the window slider kit.

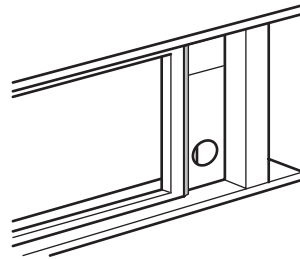

INSTALLATION IN A SLIDING SASH WINDOW

1. Cut the foam seals-adhesive type (A) to the proper lengths and attach them to the window and stool.

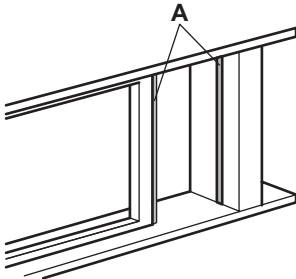

5. Cut the foam seals to an appropriate length and seal the open gap between the sliding sash and outer window sash, as shown.

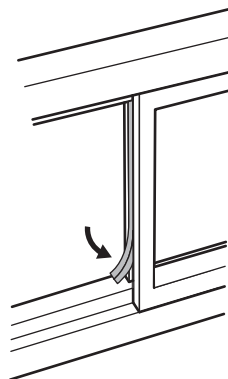

2. Attach the window slider kit to the window stool. Adjust the length of the window slider kit according to the height of window. Cut the adjustable window slider kit if the height of window is less than 67,5 cm.

CONTROL PANEL

CONTROL PANEL

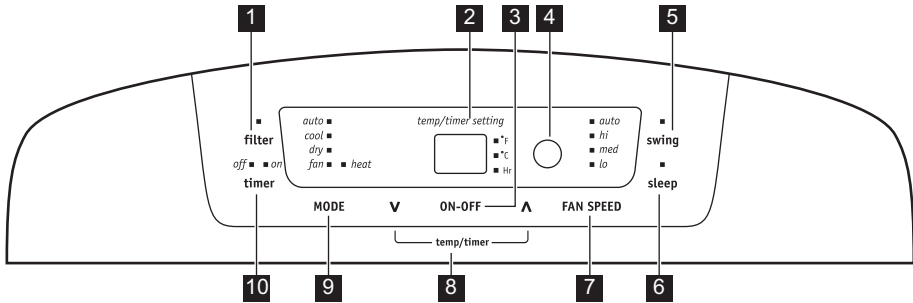

- 1** CHECK FILTER RESET BUTTON
- 2** DISPLAYS TEMPERATURE/TIME
- 3** TURNS UNIT ON OR OFF
- 4** REMOTE SIGNAL RECEIVER
- 5** SWING BUTTON (SWING)

- 6** ACTIVATES TIMER (TIMER)
- 7** SET MODE (MODE)
- 8** ADJUSTS TEMPERATURE OR TIME
- 9** SETS FAN SPEED (FAN SPEED)
- 10** SLEEP MODE (SLEEP)

REMOTE CONTROL

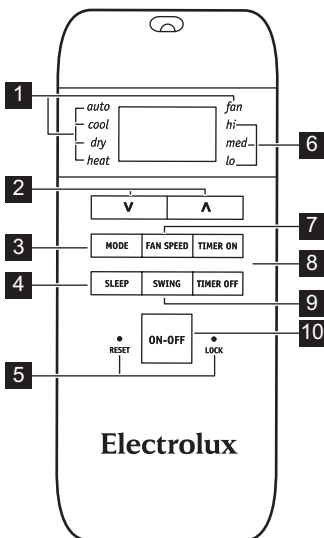

- 1** MODE INDICATION
- 2** TEMPERATURE/TIMER CONTROL BUTTONS
- 3** MODE SELECTOR (MODE)
- 4** SLEEP BUTTON (SLEEP)
- 5** RESET+LOCK PIN BUTTONS (RESET/LOCK)
- 6** FAN SPEED SELECTION
- 7** FAN SPEED SELECTOR (FAN SPEED)
- 8** TIMER BUTTONS (TIMER ON/TIMER OFF)
- 9** SWING BUTTON (SWING)
- 10** ON/OFF BUTTON

BATTERY SIZE: AAA

Warning! Do not mix old and new batteries. Do not mix alkaline, standard (carbon-zinc) or rechargeable (nickel-cadmium) batteries.

The Reset button RESET is depressed when you want to return to the initial factory settings. The Lock button LOCK is depressed to lock the keypad so the settings cannot be changed. The key symbol will

appear in the display of the remote control; depress the Lock button LOCK again to re-

lease. Use a small pin to depress these buttons.

OPERATING INSTRUCTIONS

Important! The following instructions represent the Control Panel. The same instructions can be used for the Remote Control.

COOLING MODE (COOL)

In this mode the exhaust adaptor hose MUST be used.

1. Press the Mode button (MODE) until the Cooling (COOL) indicator lights.
2. Press Temperature buttons **▲▼** for desired setting.
3. Press the Fan button (FAN SPEED) for desired fan speed.

HEATING MODE (HEAT) (ON SOME MODELS)

In this mode you do not need to use the exhaust adaptor hose.

1. Press the Mode button (MODE) until the Heating (HEAT) indicator lights.
2. Press the Temperature buttons **▲▼** for the desired heat setting.

DRY MODE (DRY)

In this mode you do not need to use the exhaust adaptor hose, BUT the water collected must be discharged. See "Drainage" section.

1. Press the Mode button (MODE) until the Dry (DRY) indicator lights.
2. The fan will run at low speed and the display will show the room temperature.
3. Keep doors and windows closed for best effect.

AUTO MODE (AUTO)

Always have the exhaust hose attached in this mode.

When you set the air conditioner in Auto mode (AUTO), it will automatically select cooling, heating (inapplicable for cooling only models) or fan only operation, depending on what temperature you have selected and the room temperature. The air conditioner will control room temperature automatically round the temperature point set

by you. Under Auto mode (AUTO) you can not select the fan speed.

FAN MODE (FAN)

In this mode there is no need to use the exhaust hose or drainage hose. However, if you require stale or smoky air to be removed from the room, hook up the duct accessories as described in the "Exhausting hot Air" section.

1. Press the Mode button (MODE) until the Fan (FAN) indicator lights
2. Press the Fan (FAN SPEED) button to choose the desired fan speed.
3. The fan will run at the selected speed and the display will show the room temperature.

TIMER OPERATION (TIMER)

You can set both delay stop and delay start while unit is in ON position or OFF position. When unit is in ON position, first press the Timer button (TIMER) to go to delay stop setting, then timer off (TIMER OFF) light will illuminate. Tap or hold the up arrow **▲** or the down arrow **▼** to change delay stop timer at 0,5 hour increments up to 10 hours, then at 1 hour increments up to 24 hours. Then press the Timer button (TIMER) to confirm the setting (the control will confirm the setting automatically after 5 seconds) and go to delay start setting. Use the same way as above to set the delay start timing. If you don't need to set delay start, press the Timer button (TIMER) again to exit. After 5 second the control will automatically change the display back to previous temperature display. If you want to check remain timing, press the Timer button (TIMER). The delay start operation automatically selects mode, temperature and fan speed the same as last operation you set.

When unit is in OFF position, press the Timer button (TIMER) to go to delay start setting, then timer on (TIMER ON) light will illuminate. Set the delay start and delay stop timing the same way as above.

To cancel the timer setting simply tap **V** or **Λ** button to change the timing to 0.0.

SLEEP OPERATION (SLEEP)

In this mode the selected temperature will increase by 1° C 30 minutes after the mode is selected. The temperature will then increase by another 1° C after an additional 30 minutes. This new temperature will be maintained for 7 hours before it returns to the originally selected temperature. This ends the Sleep mode (SLEEP) and the unit will continue to operate as originally programmed. The Sleep mode (SLEEP) program can be canceled at any time during operation by again pressing Sleep button (SLEEP).

Important! This feature is unavailable under Fan (FAN) and Dry (DRY) modes.

SWING OPERATION (SWING)

When you turn on the unit, the louver will swing and stop at a certain angle. You can press the Swing button (SWING) to let the louver swing automatically. Press the Swing button (SWING) while you want the louver stop at desired angle.

CHECK FILTER FEATURE (FILTER)

The feature is a reminder to clean the air filter (see "Care and Cleaning") for more efficient operation. The LED light above the Filter button (FILTER) will illuminate after 250 hours of operation. To reset after cleaning the filter, press the Filter button (FILTER) and the light will go off.

DRAINAGE

During the dehumidifying mode, you will need a garden hose (sold separately) to drain the condensate from the unit. Remove the rubber stopper from the hose connector, then screw on a garden hose to the connector as shown.

The hose may then:

1. Discharge into a drain that is lower than the unit.
2. Be connected to a condensate pump (sold separately).

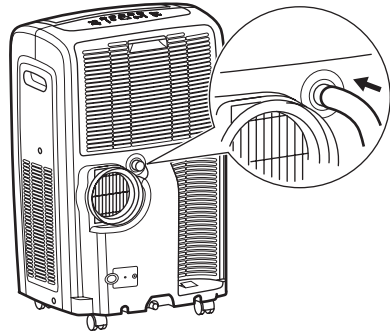

REMOTE CONTROL STORAGE

The door on side of the unit is for storing the remote. To open press it as shown below. To close, simply push it back into position.



ADDITIONAL NOTES ON OPERATION

- The cooling circuit has an automatic 3 minutes delayed start if the unit is turned off and on quickly. This prevents overheating the compressor and possible circuit breaker tripping. The fan will continue to run during this time.
- The control will maintain the set temperature within 1° C between 17° C and 30° C (62° F and 86° F).
- The control is capable of displaying temperature in degrees Fahrenheit or degrees Celsius. To convert from one to the other and back, press and hold the temperature buttons **V** and **Λ** together for 3 seconds.
- There is 2-second delay for the compressor shutting down when selecting

Fan only (FAN) or Heat (HEAT). This is to cover possibility of having to roll through to select another mode.

- After a power outage, the unit will memorize the last setting and return the unit to the same setting once power is restored.

CARE AND CLEANING

Important! Clean your air conditioner occasionally to keep it looking new. Be sure to unplug the unit before cleaning to prevent shock or fire hazards.

AIR FILTER CLEANING

- The unit has three filters, they are filter **A**, **B** and **C**. Grasp the upper panel tab and take off the filter **A**, which is placed behind the grill of the back panel.

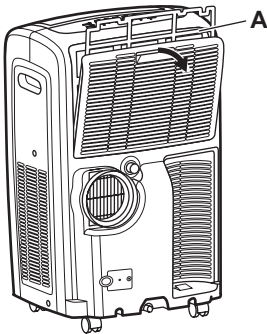

- Remove the lower filter **B** and **C** by loosening the screws. Take down the air inlet grill, then remove the air filter as shown.

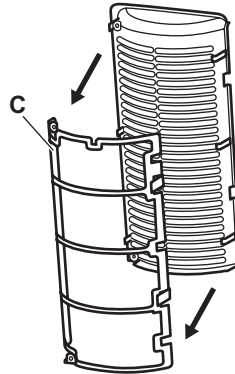
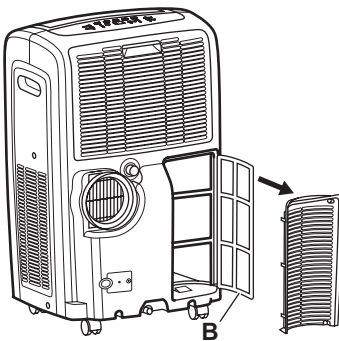

- Wash the filter using liquid dishwashing detergent and warm water. Rinse filter thoroughly. Gently shake excess water from the filter. Be sure filter is thoroughly dry before replacing.
- Or, instead of washing you may vacuum the filter clean.

CABINET CLEANING

! **Caution!** Be sure to unplug the air conditioner to prevent shock or fire hazard.

- The cabinet front may be dusted with an oil-free cloth or washed with cloth dampened in a solution of warm water and mild liquid dishwashing detergent. Rinse thoroughly and wipe dry.
- Never use harsh cleaners, wax or polish on the cabinet front.
- Be sure to wring excess water from the cloth before wiping around the controls. Excess water in or around the controls may cause damage to the air conditioner.

WINTER STORAGE

If you plan to store the appliance during the winter, cover it with plastic or return it to its carton.

WHAT TO DO IF...

Problem	Possible cause	Remedy
Air conditioner will not operate	Wall plug disconnected.	Push plug firmly into wall outlet.
	Plug current device tipped.	Press the reset button (RESET).
	House fuse blown or circuit breaker tripped.	Replace fuse with time delay type or reset circuit breaker.
	Control is OFF.	Turn control ON and set to the desired setting.
	Shut off in Heating Mode (HEAT). When the air outlet exceeds 70°C (158°F), the automatic heat protection engages.	Remove any blockages and let appliance cool down.
Air from unit does not feel cold enough.	Room temperature lower than the set temperature (Cooling Mode (COOL)).	Reset the temperature.
	Room temperature higher than the set temperature (Heating Mode (HEAT)).	Reset the temperature.
Air conditioner cooling, but room is too warm - NO ice forming on cooling coil behind decorative front.	Room temperature below 16°C (60°F). Cooling may not occur until room temperature rises above 16°C (60°F).	Reset to a lower temperature.
	Compressor shut-off by changing modes.	Wait approximately 3 minutes and listen for compressor to re-start when set in the Cooling Mode (COOL).
Air conditioner cooling, but room is too warm - ice forming on cooling coil behind decorative front.	Outdoor temperature below 16°C (60°F).	To defrost the coil, set the Fan Mode (FAN).
	Air filter may be dirty.	Clean filter. Refer to "Care and Cleaning". To defrost the coil, set the Fan Mode (FAN).
	Temperature is set too low for night-time cooling.	To defrost the coil, set the Fan Mode (FAN). Then, set temperature to a higher settings.
	Exhaust duct not connected or blocked.	See "Exhausting Hot Air"
Air conditioner cooling, but room is too warm - ice forming on cooling coil behind decorative front.	Dirty air filter - air restricted.	Clean air filter. Refer to "Care and Cleaning".
	Temperature is set too high.	Set temperature to a lower settings.
	Air directional louvers positioned improperly.	Position louvers for better air distribution.
	Front of unit is blocked by drapes, blinds or furniture, etc.- restricts air distribution.	Clear blockage in front of unit.

Problem	Possible cause	Remedy
	Doors, windows, registers, etc. open — cool air escapes.	Close doors, windows, registers, etc.
	Unit recently turned on in hot room.	Allow additional time to remove “stored heat” from walls, ceiling, floor and furniture.
Air conditioner turns on and off rapidly.	Dirty air filter - air restricted.	Clean air filter.
	Outside temperature extremely hot.	Set Fan Speed (FAN SPEED) to a faster setting to bring air through cooling coils more frequently.
Noise when unit is cooling.	Air movement sound.	This is normal. If too loud, set to lower Fan (FAN) setting.
	Vibration from uneven floor.	Move or support appliance correctly or even surface.
Room too cold.	Set temperature too low.	Increase set temperature.
Room too hot.	Set temperature too high.	Lower setting.
The display shows error code E4	The room temperature sensor has failed.	Call for service.
The display shows error code E5	The evaporator temperature sensor has failed.	Call for service.
The display shows error code E4	The display panel communication has failed.	Call for service.
The display shows error code P1	Bottom tray is full.	Carefully move the unit to a drain location, remove the bottom drain plug and let the water drain away. Restart the machine until the P1 disappears. If error repeats, call for service.

ENVIRONMENT CONCERNS

The symbol  on the product or on its packaging indicates that this product may not be treated as household waste. Instead it should be taken to the appropriate collection point for the recycling of electrical and electronic equipment. By ensuring this product is disposed of correctly, you will help prevent potential negative consequences for the environment and human health, which could otherwise be caused by inappropriate waste handling of this product. For more detailed information about recycling of this product, please contact your local council, your household

waste disposal service or the shop where you purchased the product.

Important! The battery supplied with this product contains traces of lead.

FOR EU: The crossed-out wheeled bin implies that used batteries should not be put to the general household waste! There is a separate collection system for used battery to allow proper treatment and recycling in accordance with legislation. Please contact your local authority for details on the collection and recycling schemes.

For Switzerland: The used battery is to be returned to the selling point.

For other non-EU countries: Please contact your local authorities for correct method of disposal of the used battery.

 Battery, including those which is heavy metal-free should not be disposed of

with household waste. Please dispose of used battery in an environmentally sound manner.

Find out about the legal regulations which apply in your area.

