

**PREDATOR** HELIOS 300

User's Manual

© 2017. All Rights Reserved.

Predator Helios 300

Covers: G3-571 / G3-572 / G3-573 / PH317-51

This revision: May 2017

## Sign up for an Acer ID and enjoy great benefits

Open the *Acer Portal* app to sign up for an Acer ID or sign in if you already have an Acer ID.

**There are three great reasons for you to get an Acer ID:**

- Create your own connected world.
- Get the latest offers and product information.
- Register your device for quick, personalized customer support.

For more information, please visit the Acer BYOC website:

[www.acer.com/byoc-start](http://www.acer.com/byoc-start)



### **Important**

**This manual contains proprietary information that is protected by copyright laws. The information contained in this manual is subject to change without notice. Images provided herein are for reference only and may contain information or features that do not apply to your computer. Acer Group shall not be liable for technical or editorial errors or omissions contained in this manual.**

Model number: \_\_\_\_\_

Serial number: \_\_\_\_\_

Date of purchase: \_\_\_\_\_

Place of purchase: \_\_\_\_\_

# TABLE OF CONTENTS

<b>First things first</b>	<b>6</b>	<b>Bluelight Shield</b>	<b>39</b>
Your guides.....	6	<b>Securing your computer</b>	<b>41</b>
Basic care and tips for using your computer.....	7	Using a computer security lock.....	41
Turning your computer off.....	7	Using passwords.....	41
Taking care of your computer.....	7	Entering passwords.....	42
Taking care of your AC adapter.....	8	<b>BIOS utility</b>	<b>43</b>
Cleaning and servicing.....	8	Boot sequence.....	43
<b>Your Predator notebook tour</b>	<b>9</b>	Setting passwords.....	43
Screen view.....	9	<b>Power management</b>	<b>44</b>
Keyboard view.....	10	Saving power.....	44
Left view.....	11	<b>Battery pack</b>	<b>46</b>
USB Type-C information.....	11	Battery characteristics.....	46
USB 3.0 information.....	11	Charging the battery.....	46
Right view.....	12	Optimizing battery life.....	47
Rear view.....	12	Checking the battery level.....	48
Base view.....	13	Battery-low warning.....	48
<b>Using the keyboard</b>	<b>14</b>	<b>Traveling with your computer</b>	<b>49</b>
Lock keys.....	14	Disconnecting from the desktop....	49
Hotkeys.....	14	Moving around.....	49
Windows keys.....	16	Preparing the computer.....	49
<b>Using the Precision Touchpad</b>	<b>17</b>	What to bring to meetings.....	50
Touchpad gestures.....	17	Taking the computer home.....	50
Changing touchpad settings.....	18	Preparing the computer.....	50
<b>Recovery</b>	<b>21</b>	What to take with you.....	51
Creating a factory default backup.	21	Special considerations.....	51
Backing up your wireless and LAN drivers.....	24	Setting up a home office.....	51
Restoring your computer.....	24	Traveling with the computer.....	52
Reset this PC and keep my files.....	24	Preparing the computer.....	52
Reset this PC and remove everything	26	What to take with you.....	52
<b>Using a Bluetooth connection</b>	<b>28</b>	Special considerations.....	52
Enabling and disabling Bluetooth.	28	Traveling internationally.....	53
Enable Bluetooth and add a device	28	Preparing the computer.....	53
<b>Connecting to the Internet</b>	<b>31</b>	What to bring with you.....	53
Connecting to a wireless network..	31	Special considerations.....	53
Connecting to a wireless LAN.....	31	<b>Universal Serial Bus (USB)</b>	<b>56</b>
Connecting with a cable.....	35	<b>USB Type-C port</b>	<b>57</b>
Built-in network feature.....	35	<b>SD card reader</b>	<b>58</b>
Connecting to a cellular network...	35	<b>Video and audio connectors</b>	<b>59</b>
<b>PredatorSense</b>	<b>36</b>	Connecting a monitor.....	59
The PredatorSense main screen ...	36	Headphones and microphone.....	59
Overclocking.....	37	<b>HDMI</b>	<b>60</b>
Fan Control.....	37	<b>Frequently asked questions</b>	<b>62</b>
PredatorSense settings.....	38	Requesting service.....	64
		Tips and hints for using Windows 10.....	66
		How do I get to Start?.....	66

How do I turn off my computer? .....	66	Troubleshooting tips .....	72
How do I unlock my computer? .....	67	Error messages .....	72
How do I set the alarm? .....	68	<b>Internet and online security</b>	<b>74</b>
Where are my apps? .....	69	First steps on the net .....	74
What is a Microsoft ID (account)? ...	70	Protecting your computer .....	74
How do I check for Windows		Choose an Internet Service Provider	74
updates? .....	70	Network connections .....	76
Where can I get more information? .	71	Surf the Net! .....	78
Troubleshooting .....	72	Internet security software .....	78

# Getting started...

## **In this section you will find:**

- Useful information on caring for your computer and your health
- Where to find the power button, ports and connectors
- Tips and tricks for using the touchpad and keyboard
- How to create recovery backups
- Guidelines for connecting to a network and using Bluetooth
- Information on using Predator's bundled software

# FIRST THINGS FIRST

---

We would like to thank you for making this Predator notebook your choice for meeting your mobile computing needs.

## Your guides

To help you use your Predator notebook, we have designed a set of guides:

First off, the **Setup Guide** helps you get started with setting up your computer.

The **Quick Guide** introduces you to the basic features and functions of your new computer. For more on how your computer can help you to be more productive, please refer to the **User's Manual**. This guide contains detailed information on such subjects as system utilities, data recovery, expansion options and troubleshooting.

Once you have connected to the internet, you can download updates for your computer from:

<http://go.acer.com/?id=17883>

1. The link will open the Predator Service & Support webpage.
2. Scroll down to *Drivers and Manuals* and search for your model by pasting in or manually entering the serial number, SNID, or product model.
3. From this page you can also download and install the Predator identification utility that will automatically detect your computer's serial number and SNID and allow you to copy it to the clipboard.
4. Once you have found your product model, any updates, or documents will be listed.

# Basic care and tips for using your computer

## Turning your computer off

To turn the power off, do any of the following:

- Use the Windows shutdown command: Press the *Windows key* or select the *Windows Start button*, select **Power** > **Shut down**.
- Right-click the *Windows Start button* > **Shut down or sign out** > **Shut down**.

If you need to power down the computer for a short while, but don't want to completely shut it down, you can put it to *Sleep* by doing any of the following:

- Press the power button.
- Press the sleep hotkey.
- Press the *Windows key* or select the *Windows Start button*, select **Power** > **Sleep**.
- Right-click the *Windows Start button* > **Shut down or sign out** > **Sleep**.



### Note

*If you cannot power off the computer normally, press and hold the power button for up to ten seconds to shut down the computer. If you turn off the computer and want to turn it on again, wait at least two seconds before powering up.*

## Taking care of your computer

Your computer will serve you well if you take care of it.

- Only use the adapter provided with your device, or an Acer-approved adapter to power your device.
- Do not expose the computer to direct sunlight. Do not place it near sources of heat, such as a radiator.
- Do not expose the computer to temperatures below 0° C (32° F) or above 50° C (122° F).
- Do not subject the computer to magnetic fields.

- Do not expose the computer to rain or moisture.
- Do not spill water or any liquid on the computer.
- Do not subject the computer to heavy shock or vibration.
- Do not expose the computer to dust or dirt.
- Never place objects on top of the computer.
- Do not slam the computer display when you close it.
- Never place the computer on uneven surfaces.

## **Taking care of your AC adapter**

Here are some ways to take care of your AC adapter:

- Do not connect the adapter to any other device.
- Do not step on the power cord or place heavy objects on top of it. Route the power cord and any cables away from where people walk.
- When unplugging the power cord, do not pull on the cord itself but pull on the plug.
- The total ampere ratings of the equipment plugged in should not exceed the ampere rating of the cord if you are using an extension cord. Also, the total current rating of all equipment plugged into a single wall outlet should not exceed the fuse rating.

## **Cleaning and servicing**

When cleaning the computer, follow these steps:

1. Turn off the computer.
2. Disconnect the AC adapter.
3. Use a soft, moist cloth. Do not use liquid or aerosol cleaners.

If your computer is dropped or visibly damaged, or does not work normally, please contact your nearest authorized Predator service center.



# YOUR PREDATOR NOTEBOOK TOUR

After setting up your computer as illustrated in the Setup Guide, let us show you around your new Predator computer.

## Screen view

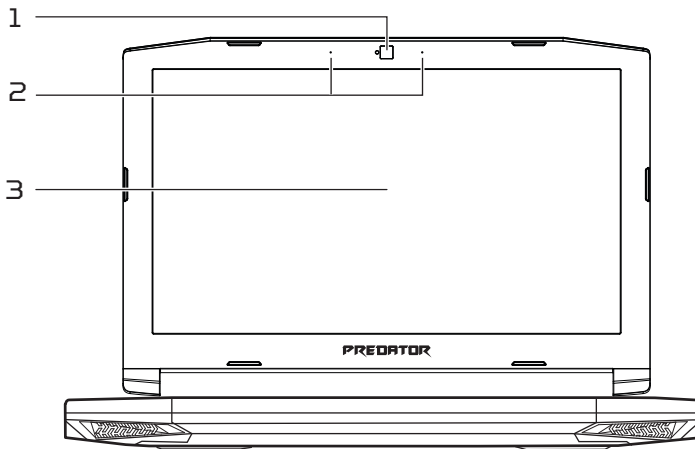

#	Icon	Item	Description
1		Webcam	Web camera for video communication. <i>A light next to the webcam indicates that the webcam is active.</i>
2		Microphones	Internal stereo digital microphones for sound recording.
3		Screen	Displays computer output.



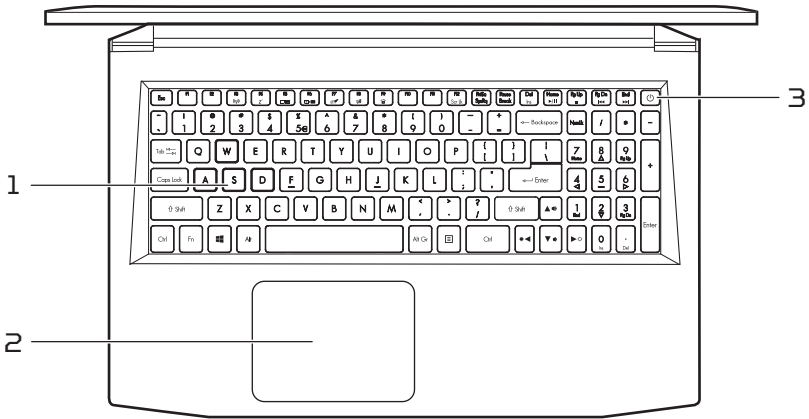



# Keyboard view

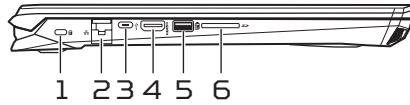

#	Icon	Item	Description
1		Keyboard	For entering data into your computer. <i>See "Using the keyboard" on page 14.</i>
2		Touchpad	Touch-sensitive pointing device. <i>The touchpad and selection buttons form a single surface. Press down firmly on the touchpad surface to perform a left click. Press down firmly on the lower right corner to perform a right click.</i>
3		Power button	Turns the computer on and off.

## Left view



#	Icon	Item	Description
1		Kensington lock slot	Connects to a Kensington-compatible security lock.
2		Ethernet (RJ-45) port	Connects to an Ethernet 10/100/1000-based network. <i>Pull the lip down to open the port fully.</i>
3		USB Type-C port	Connects to USB devices with a USB Type-C connector.
4		HDMI port	Supports high-definition digital video connections.
5		USB port with power-off charging	Connects to USB devices.
6		SD card reader	Accepts one Secure Digital (SD or SDHC) card. <i>Only one card can operate at a time.</i>

## USB Type-C information





- USB 3.1 Gen 1 with transfer speeds up to 5 Gbps.
- Delivers up to 3 A at 5 V DC for USB charging.

## USB 3.0 information

- USB 3.0 compatible ports are blue.
- Compatible with USB 3.0 and earlier devices.
- For optimal performance, use USB 3.0-certified devices.
- Defined by the USB 3.0 specification (SuperSpeed USB).

## Right view



#	Icon	Item	Description
1		Headset/ speaker jack	Connects to audio devices (e.g., speakers, headphones) or a headset with microphone.
2		USB ports	Connect to USB devices.
3		Power indicator	Indicates the computer's power status.
			Indicates the computer's battery status. <b>Charging:</b> The light shows amber when the battery is charging. <b>Fully charged:</b> The light shows blue when in AC mode.
4		DC-in jack	Connects to an AC adapter.

## Rear view

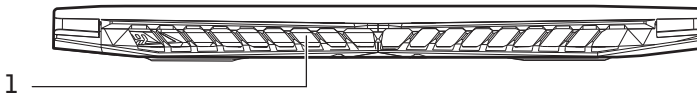

#	Icon	Item	Description
1		Ventilation and cooling fan	Allows the computer to stay cool. <i>Do not cover or obstruct the openings.</i>

## Base view

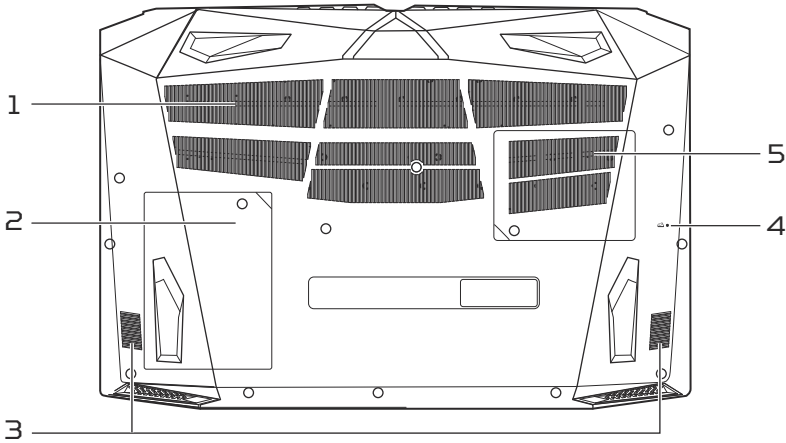

#	Icon	Item	Description
1		Ventilation and cooling fan	Allows the computer to stay cool. <i>Do not cover or obstruct the openings.</i>
2		Main storage compartment	Houses the computer's main storage. <i>You may upgrade your computer's main storage. Predator recommends asking an approved service center to do this.</i>
3		Speakers	Deliver stereo audio output.
4		Battery reset pinhole	Simulates removing and reinstalling the battery. <i>Insert a paperclip into the hole and press for four seconds.</i>
5		Memory compartment	Houses the computer's memory. <i>You may upgrade your computer's memory. Predator recommends asking an approved service center to do this.</i>

# USING THE KEYBOARD

The keyboard has full-sized keys and a separate numeric keypad, separate cursor, lock, Windows, function and special keys.

## Lock keys



The keyboard has lock keys which you can use to turn keyboard functions on and off.

Lock key	Description
Caps Lock	When Caps Lock is on, all alphabetic characters typed are in uppercase.
Num Lock	When Num Lock is on, the keypad is in numeric mode. The keys function as a calculator (complete with the arithmetic operators +, -, *, and /). Use this mode when you need to do a lot of numeric data entry.
Scroll Lock Fn + F12	When Scroll Lock is on, the screen moves one line up or down when you press the up or down arrow keys respectively. Scroll Lock does not work with some applications.

## Hotkeys

The computer employs hotkeys or key combinations to access most of the computer's controls like screen brightness and volume output.



To activate hotkeys, press and hold the **Fn** key before pressing the other key in the hotkey combination.

Hotkey	Icon	Function	Description
Fn + F3		Airplane mode	Turns on / off the computer's network devices.
Fn + F4		Sleep	Puts the computer in Sleep mode.

Hotkey	Icon	Function	Description
<b>Fn + F5</b>		Display toggle	Switches display output between the display screen, external monitor (if connected) and both.
<b>Fn + F6</b>		Display off	Turns the display screen backlight off to save power. Press any key to return.
<b>Fn + F7</b>		Touchpad toggle	Turns the built-in touchpad on and off.
<b>Fn + F8</b>		Speaker toggle	Turns the speakers on and off.
<b>Fn + F9</b>		Keyboard backlight toggle	Turns the keyboard backlight on and off.
<b>Fn + F12</b>	Scr Lk	Scroll Lock	Turns Scroll Lock on or off.
<b>Fn + Del</b>	Ins	Insert	Turns Insert on or off.
<b>Fn + ▷</b>		Brightness up	Increases the screen brightness.
<b>Fn + ◁</b>		Brightness down	Decreases the screen brightness.
<b>Fn + △</b>		Volume up	Increases the sound volume.
<b>Fn + ▽</b>		Volume down	Decreases the sound volume.
<b>Fn + Home</b>		Play/Pause	Play or pause a selected media file.
<b>Fn + Pg Up</b>		Stop	Stop playing the selected media file.
<b>Fn + Pg Dn</b>		Previous	Return to the previous media file.
<b>Fn + End</b>		Next	Jump to the next media file.

# Windows keys

The keyboard has two keys that perform Windows-specific functions.

Key	Description
 Windows key	Pressed alone it returns to the Start screen or to return to the last open app. It can also be used with other keys for special functions, please check Windows Help.
 Application key	This key has the same effect as clicking the right mouse button; it opens the application's context menu.



# USING THE PRECISION TOUCHPAD

---

The touchpad controls the arrow  (or 'cursor') on the screen. As you slide your finger across the touchpad, the cursor will follow this movement. The Precision Touchpad (PTP) is designed to provide a more uniform, smooth, and accurate touchpad experience. Many applications support precision touchpad gestures that use one or more fingers, however, some gestures may not be supported by the specific application or program you are using.

## Touchpad gestures

---

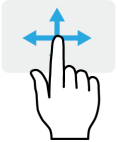

### Single-finger slide

Slide a finger across the touchpad to move the cursor.



### Single-finger press or tap

Press the touchpad down, or lightly tap the touchpad with your finger, to perform a 'click', which will select or start an item. Quickly repeat the tap to perform a double tap or 'double click'.



### Two-finger press

Lightly tap the touchpad with two fingers to perform a  'right click'. In the *Start* screen, this will toggle the app commands. In most apps this will open a context menu related to the selected item.



### Two-finger slide

Swiftly scroll through web pages, documents and playlists by placing two fingers on the touchpad and moving both in any direction.

---



## Two-finger pinch

Zoom in and out of photos, maps and documents with a simple finger-and-thumb gesture.



## Three-finger press

Lightly tap the touchpad with three fingers to open Cortana (if your computer supports Cortana) or open the *Action Center* (if your computer does not support Cortana).

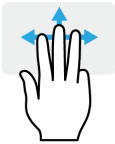

## Three-finger swipe

Swipe across the touchpad with three fingers.

- Swipe up to open *Task View*. Move the cursor over a window and tap the touchpad to select that window, or swipe downwards to exit *Task View*.
- Swipe down to minimize all open windows and show *Desktop*; swipe upwards to restore the minimized windows.
- Swipe left or right to switch between open windows.

The precision touchpad includes added technology features that help recognize and prevent unintentional gestures such as accidental taps, gestures, and pointer movement.



### Note

*The touchpad is sensitive to finger movement; the lighter the touch, the better the response. Please keep the touchpad and your fingers dry and clean.*

## Changing touchpad settings

To change the touchpad settings to suit your personal requirements, please do the following.

1. In the icon tray in the lower right-hand corner of the screen, select the *Notifications* icon to open the *Notifications* pane.

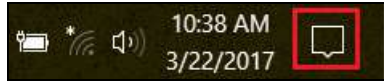

2. Select **All settings**.

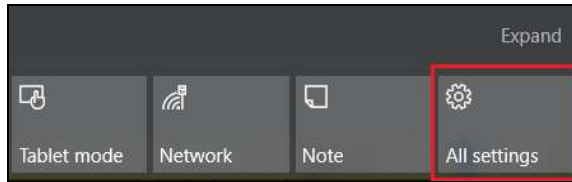

3. Select **Devices > Mouse & touchpad**.

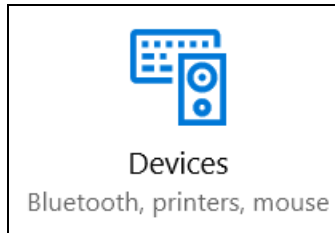

4. Now you can adjust the settings to suit your personal needs. You can change the primary button for left- or right-handed use, turn the touchpad off if you prefer to use a mouse, or set a delay to prevent the cursor from moving if you accidentally tap the touchpad with your palm while working. Scroll down to see more settings.

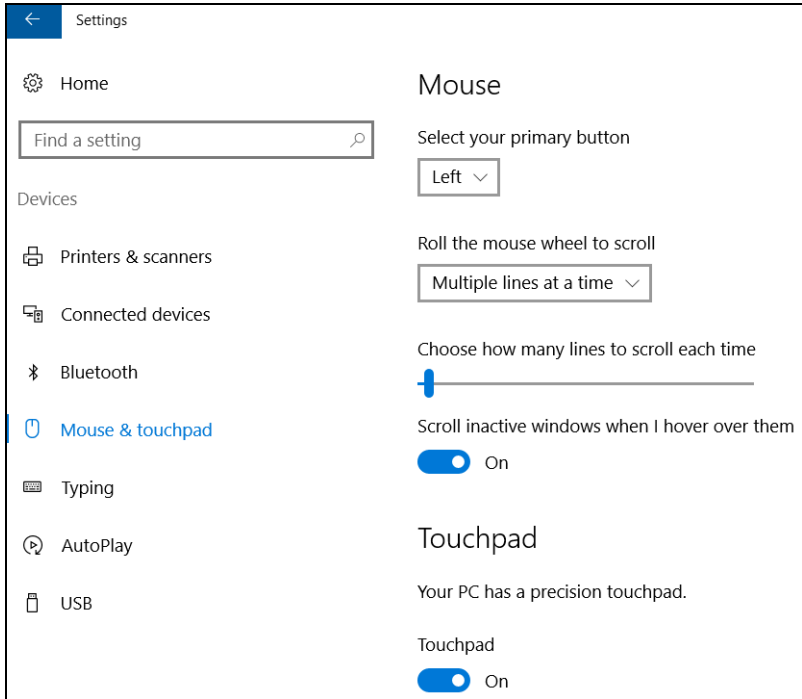

# RECOVERY

---

If you are having trouble with your computer, and the frequently asked questions (**see Got a question? on page 61**) do not help, you can recover your computer.

This section describes the recovery tools available on your computer. Predator provides *Acer Care Center*, which allows you to reset your PC, refresh your PC, or create a factory default backup.



## Note

*Acer Care Center is only available with a pre-installed Windows operating system.*



## Important

**We recommend that you create a Factory Default Backup as soon as possible. In certain situations a full recovery will require a USB recovery backup.**

## Creating a factory default backup

Backup allows you to quickly and easily back up your operating system, installed apps and data.

1. From *Start*, select **All apps** then **Predator**. Select **Predator Recovery Management** in the list of Predator apps.



## Note

*Since the recovery backup requires at least 8 GB of storage after formatting, it is recommended to use a USB drive with a capacity of 16 GB or larger.*

2. Select the **Backup** tab and click **Get Started** for **Create Factory Default Backup** to open the **Recovery Drive** window.

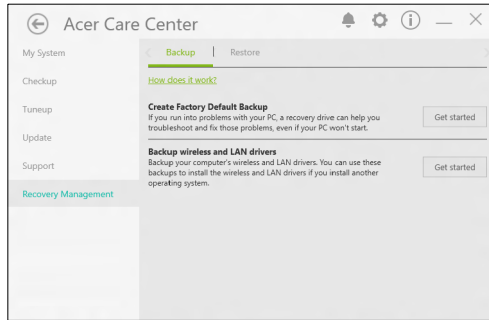

3. Make sure **Backup system files to the recovery drive** is selected and click **Next**.

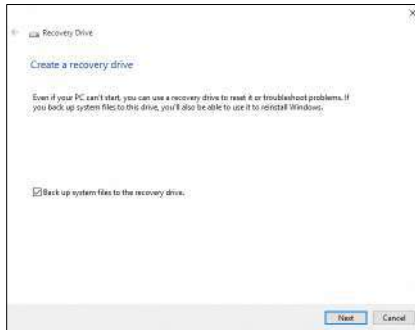

4. Plug in the USB drive and wait for the PC to detect the USB drive then click **Next**.

- *Since the recovery backup requires at least 8 GB of storage after formatting, it is recommended to use a USB drive with a capacity of 16 GB or larger.*



5. Everything on the drive will be deleted. Click **Create** to continue.
6. You will be shown the backup progress on the screen.
7. Follow the process until it completes.
8. After creating the recovery backup, you can choose to delete the recovery information on your computer. If you delete this information, you can only use the USB recovery backup to restore your computer, if you lose or erase the USB drive, you cannot restore your computer.
9. Unplug the USB drive and label it clearly.



### **Important**

**Write a unique, descriptive label on the backup, such as 'Windows Recovery Backup'. Make sure you keep the backup in a safe place that you will remember.**

## Backing up your wireless and LAN drivers

Back up your wireless and LAN drivers. You can use these backups to install the wireless and LAN drivers if you install another operating system.

1. From *Start*, select **All apps** then **Predator**. Select **Predator Recovery Management** in the list of Predator apps.
2. Select the *Backup* tab and click **Get started** for *Backup wireless and LAN drivers*. Choose a folder to save your drivers and select **OK**.

## Restoring your computer

Recovery Management allows you to quickly and easily restore your computer back to its default status. You can choose to keep your files or remove them before reinstalling Windows.

## Reset this PC and keep my files

1. From *Start*, select **All apps** then **Predator**. Select **Predator Recovery Management** in the list of Predator apps.
2. Select the *Restore* tab and click **Get started** to *Choose an option*.

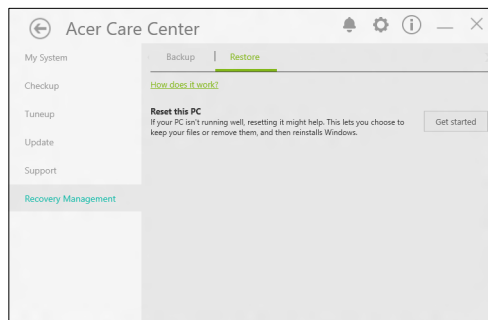



3. Select **Keep my files** to refresh your PC and reinstall your operating system without removing your personal files. Click **Next** to continue.

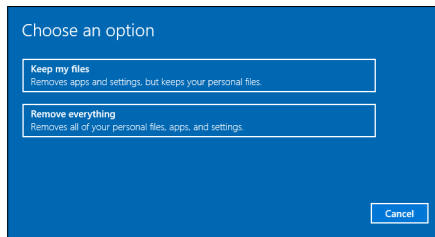

### Important

If you have apps installed on your PC, they will be removed.

4. Resetting the PC will reinstall Windows, change settings back to their factory defaults and remove all preinstalled apps and programs without removing your personal files. Click **Reset** to continue.

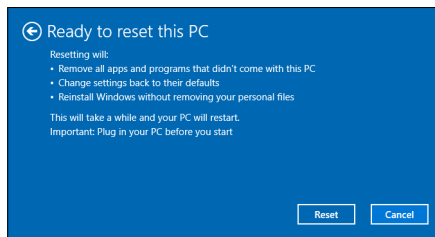

5. You will be shown the reset progress on the screen. The screen will turn off during the reset process.
6. The screen will turn back on when it is installing Windows. Your PC will restart several times during the reset process.
7. Follow the process until it completes.
8. When your PC has completed the reset process, Windows will have been reset back to its factory default settings without removing your personal files.

## Reset this PC and remove everything

1. From *Start*, select **All apps** then **Predator**. Select **Predator Recovery Management** in the list of Predator apps.
2. Select the *Restore* tab and click **Get Started** to *Choose an option*.

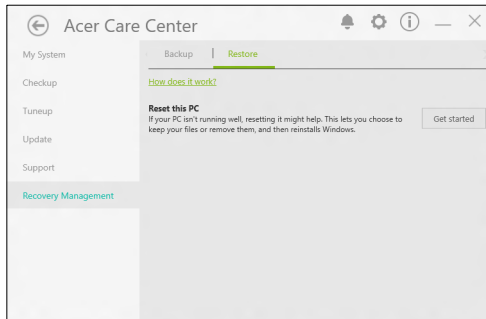

3. Select **Remove everything** to reset your PC back to its factory default. This process will reinstall your operating system and remove all of your personal files, apps, and settings.

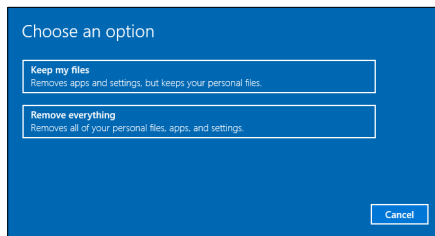

4. Select **Just remove my files** if you are keeping your computer. This will be quicker, but less secure. Files may still be recovered with a file recovery program. Select **Remove files and clean the drive** if you are not

keeping your computer. This process will take longer, but will be more secure.



### Warning

Selecting "*Remove files and clean the drive*" will remove all of your personal files and accounts, along with pre-existing drivers that may affect your Windows installation.

5. Click **Reset** to continue.

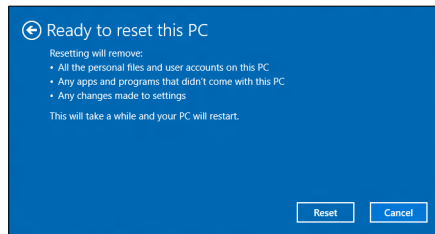

6. You will be shown the reset progress on the screen. The screen will turn off during the reset process.
7. The screen will turn back on when it is installing Windows. Your PC will restart several times during the reset process.
8. Follow the process until it completes.
9. When your PC has completed the reset process, Windows will use factory default settings.

# USING A BLUETOOTH CONNECTION

---

Bluetooth is a technology enabling you to transfer data wirelessly over short distances between many different types of devices. Bluetooth-enabled devices include computers, cell phones, tablets, wireless headsets, and keyboards.

To use Bluetooth, you must ensure the following:

1. Bluetooth is enabled on both devices.
2. Your devices are "paired" (or connected).

## Enabling and disabling Bluetooth

The Bluetooth adapter must be enabled on both devices. For your computer, this may be an external switch, a software setting, or a separate Bluetooth dongle plugged into the computer's USB port (if no internal Bluetooth adapter is available).



### Note

*Please check your devices owner's manual to determine how to turn on its Bluetooth adapter.*

## Enable Bluetooth and add a device

Every new device must first be "paired" with your computer's Bluetooth adapter. This means it must first be authenticated for security purposes. You only need to pair once. After that, simply turning on the Bluetooth adapter of both devices will connect them.

Bluetooth on your computer is disabled by default. To enable your computer's Bluetooth adapter, do the following:

1. Press the *Windows key* or select the *Windows Start button* > **Settings** > **Devices** > **Bluetooth**, and click the toggle under **Bluetooth** to enable/disable it.
2. Your computer will automatically start searching for devices, as well as make itself visible to other devices.
3. Select the device you wish to pair from the list of discovered devices, and select **Pair**.

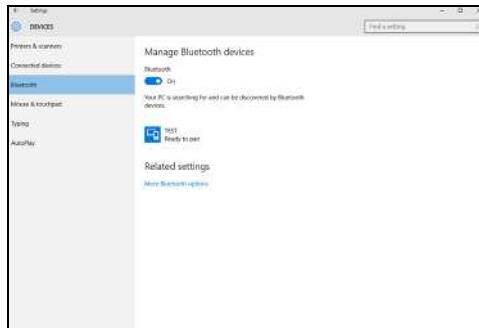

4. A code displays on your computer, which should match the code displayed on your device. Select **Yes**. Then, accept the pairing from your device.

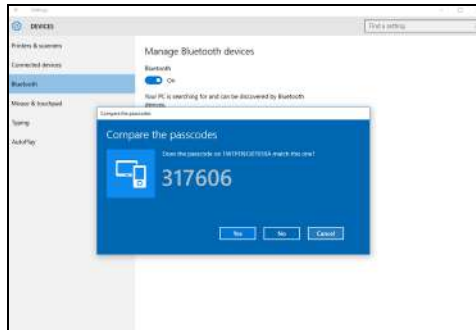

### Note

*Some devices using older versions of the Bluetooth technology require both devices to enter a PIN. In the case of one of the devices not having any inputs (as in a headset), the passcode is hardcoded into the device (usually "0000" or "1234"). Consult your device's user manual for more information.*

You can also enter the Bluetooth settings by selecting the *Notifications* icon in the lower right-hand corner of the screen to open the *Notifications* pane. From here, you can enable or disable Bluetooth or right-click on **Bluetooth** > **Go to settings** to enter the Bluetooth settings.

# CONNECTING TO THE INTERNET

---

This chapter includes general information on types of connections, and getting connected to the internet. For detailed information, please refer to **Network connections on page 91**.

Your computer's built-in network features make it easy for you to connect your computer to the internet.

First though, in order to connect to the internet from home, you'll need to sign up for internet services from an ISP [Internet Service Provider] -- usually a phone or cable company -- that will have to go to your home or office to set up internet service. The ISP will install a small box, a router or modem, that will allow you to connect to the internet.

## Connecting to a wireless network

### Connecting to a wireless LAN

A wireless LAN (or WLAN) is a *wireless local area network*, which can link two or more computers without using wires. Once connected to WLAN, you can access the internet. You can also share files, other devices, and even your internet connection itself.

Your computer's wireless connection is turned on by default and Windows will detect and display a list of available networks during setup. Select your network and enter the password if required.



#### **Warning**

**Using wireless devices while flying in aircraft may be prohibited. All wireless devices must be switched off before boarding an aircraft and during take-off, as they may be dangerous to the operation of the aircraft, disrupt communications, and even be illegal. You may turn on your computer's wireless devices only when informed that it is safe to do so by the cabin crew.**

Predator notebook computers feature an *Airplane mode* hotkey that turns the network connection on or off. You can use the network management options to turn your wireless network on/off or control what is shared over the network.

To connect to a wireless network, please follow the steps below.

1. Ensure you have a wireless router/access point and current internet connection through the ISP of your choice. Make a note of the wireless network's name and password (if necessary). If you are trying to connect to a public network (such as at a coffeeshop), make sure you have the wireless network's name.



**Note**

*Please refer to your ISP or router documentation for details on connecting to the internet.*

2. In the icon tray in the lower right-hand corner of the screen, select the *Notifications* icon to open the *Notifications* pane.

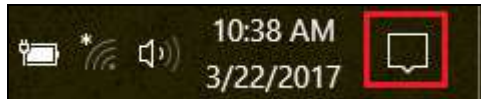

3. Select **All settings**.

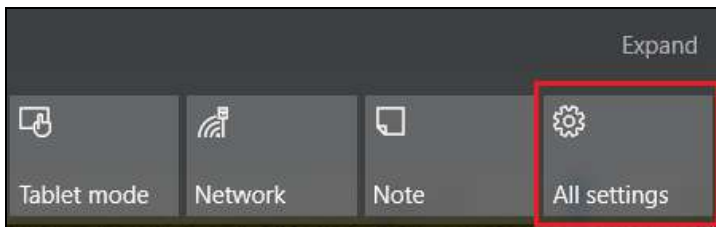



#### 4. Select **Network & internet**.

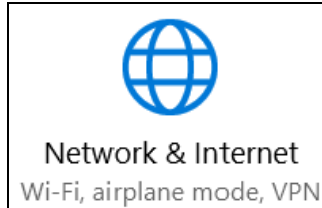

#### 5. Make sure Wi-Fi is **On** and select **Show available networks**.

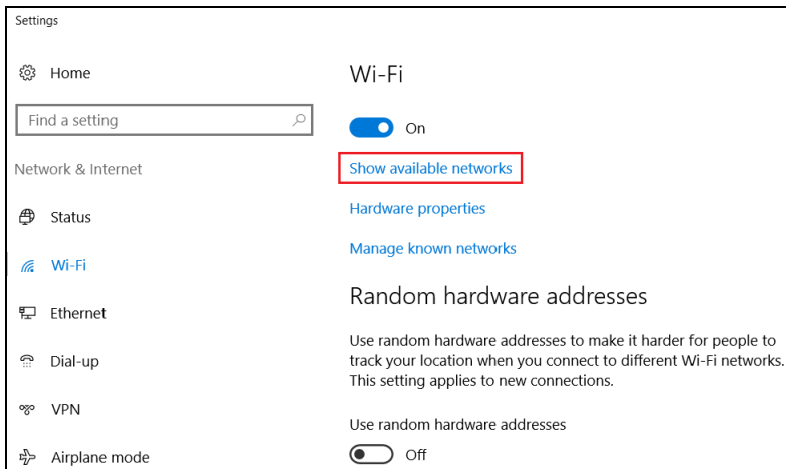

#### 6. You will see a list of available wireless networks. Select the one you wish to use.

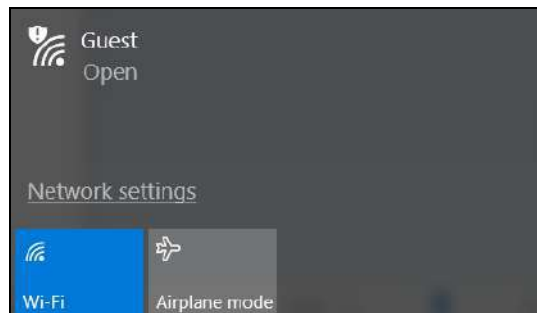

7. Once you select a wireless network, select **Connect**.

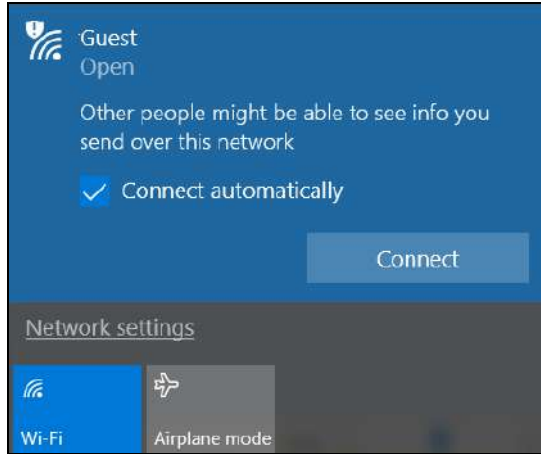

8. If required, enter the network's password.

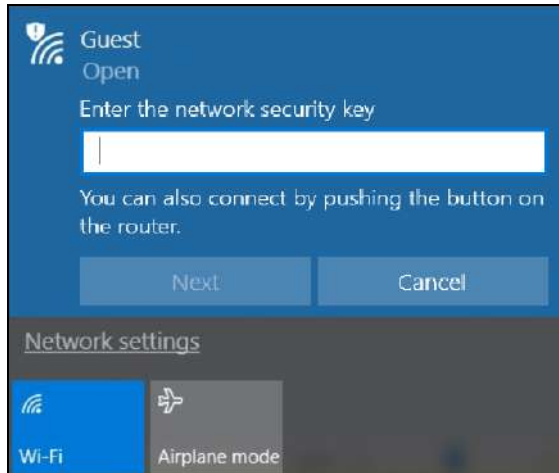

## Connecting with a cable

### Built-in network feature

If your computer has a network port, plug one end of a network cable into the network port on your computer, and the other end into a port on your router (refer to the image below.) Then, you'll be ready to get online.

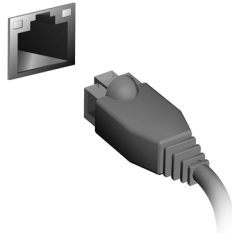

## Connecting to a cellular network

If your computer has a SIM slot, you can connect to the internet using a cellular phone network. To do this, you must have a compatible SIM card and a data contract with your cellular provider. Contact your cellular provider for more information on connecting to the internet using a cellular network.

# PREDATORSENSE

*PredatorSense* helps you to gain the edge in your games by allowing you to overclock processors and control cooling. Additional settings increase your key control by allowing you to turn off sticky keys and the Windows/Menu keys.



## Note

*Overclocking is not available on all models and configurations.*

## The *PredatorSense* main screen

The main screen gives you a one-glance overview of your computer's current status, including the GPU frequency, temperatures, and fan speeds. The screen provides fan control and overclocking options to increase performance.

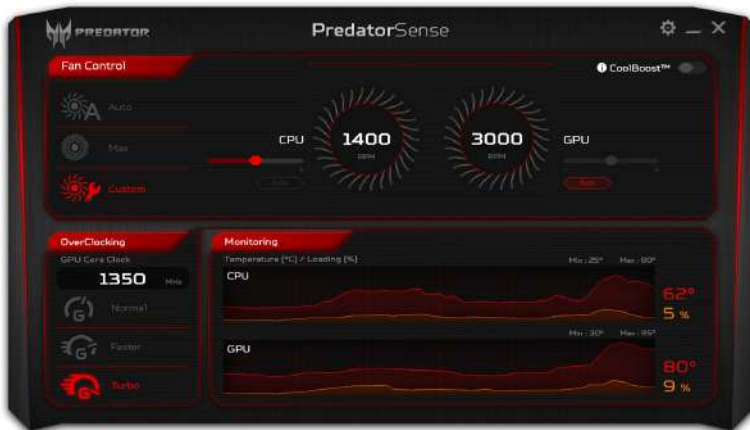

## Note

*The speeds and frequencies listed may vary depending on your computer's configuration and the power output of the CPU and GPU.*

## Overclocking



### Note

*Overclocking is not available on all models and configurations.*

The GPU in your computer supports overclocking; you may use PredatorSense to boost graphics performance. Three levels are available: **Normal** (no overclocking), **Faster** and **Turbo**.



### Note

*The AC adapter must be connected and battery charge must be over 30% in order to overclock your computer.*

If the AC adapter is disconnected or if the battery charge is lower than 30%, overclocking options will be disabled until the AC adapter is reconnected and battery charge is over 30%.



### Note

*Acer is not responsible for any damage incurred from overclocking if any third party tools are used to overclock the CPU or graphics besides PredatorSense.*



### Warning

**Your computer is designed to support GPU overclocking. However, overclocking may result in system instability. If you experience instability, shut down and restart your computer; it will restart with default settings.**

## Fan Control

You may adjust the performance of the fans cooling your computer's CPU and GPU. Three levels are available: **Auto** (default), **Max** and **Custom**.



If you select **Custom**, then you will see two sliders that allow you to set CPU and GPU cooling independently.

### *CoolBoost™*

Turn CoolBoost™ on to increase the maximum fan speed, enabling even faster fan speeds and increased cooling during heavy use.

## ***PredatorSense settings***

Click the *Settings* icon to change settings for your Predator computer. You can disable the Windows and Menu keys, and also the sticky keys feature.

An additional setting allows you to change reported temperature units (°C or °F).

# BLUELIGHT SHIELD

The Bluelight Shield can be enabled to reduce blue-light emissions from the screen to protect your eyes.

To configure the Bluelight Shield, *Search* for 'Predator Quick Access' in the Start Menu. From here you can toggle Bluelight Shield on or off, and you can choose from four different modes to fit your needs:

No.	Item	Description
1	Low Reduction	Reduces blue light emission from the LED backlit screen by 10% to 25% for basic protection.
2	Medium Reduction	Reduces blue light emission from the LED backlit screen by 26% to 45% to protect your eyes.
3	High Reduction	Reduces blue light emission from the LED backlit screen by 46% to 65% for maximum protection.
4	Long Hour Mode	Professionally tuned to reduce eye strain over an extended period of time.

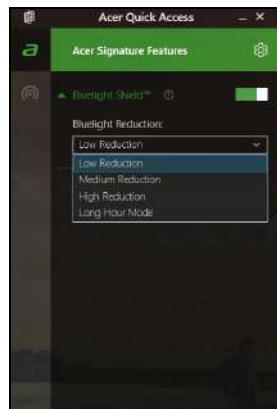

## Note

*Specifications vary depending on model.*

# Keeping your computer and data safe...

## **In this section you will find:**

- How to secure your computer
- Setting passwords
- What you need to prepare when you're traveling
- How to get the most out of your battery



# SECURING YOUR COMPUTER

---

Your computer is a valuable investment that you need to take care of. Learn how to protect and take care of your computer.

Security features include hardware and software locks — a security notch and passwords.

## Using a computer security lock

The computer comes with a computer security slot for a security lock.

Wrap a computer security lock cable around an immovable object such as a table or handle of a locked drawer. Insert the lock into the notch and turn the key to secure the lock. Some keyless models are also available.

## Using passwords

Passwords protect your computer from unauthorized access. Setting these passwords creates several different levels of protection for your computer and data:

- Supervisor Password prevents unauthorized entry into the BIOS utility. Once set, you must enter this password to gain access to the BIOS utility. **See Setting passwords on page 43.**
- User Password secures your computer against unauthorized use. Combine the use of this password with password checkpoints on boot-up and resume from Hibernation (if available) for maximum security.
- Password on Boot secures your computer against unauthorized use. Combine the use of this password with

password checkpoints on boot-up and resume from Hibernation (if available) for maximum security.



### **Important**

**Do not forget your Supervisor Password! If you forget your password, please get in touch with your dealer or an authorized service center.**

## Entering passwords

When a password is set, a password prompt appears in the center of the display screen.

- When the Supervisor Password is set, a prompt appears when you enter the BIOS utility.
- Type the Supervisor Password and press **Enter** to access the BIOS utility. If you enter the password incorrectly, a warning message appears. Try again and press **Enter**.
- When the User Password is set and the password on boot parameter is enabled, a prompt appears at boot-up.
- Type the User Password and press **Enter** to use the computer. If you enter the password incorrectly, a warning message appears. Try again and press **Enter**.



### **Important**

**You have three chances to enter a password. If you fail to enter the password correctly after three tries, the system halts. Press and hold the power button for four seconds to shut down the computer. Then turn on the computer again, and try again.**

# BIOS UTILITY

---

The BIOS utility is a hardware configuration program built into your computer's BIOS.

Your computer is already properly configured and optimized, and you do not normally need to run this utility. However, if you encounter configuration problems, you may need to run it.

To activate the BIOS utility, press **F2** while the computer logo is being displayed.

## Boot sequence

To set the boot sequence in the BIOS utility, activate the BIOS utility, then select **Boot** from the categories listed on the left of the screen.

## Setting passwords

To set a password on boot, activate the BIOS utility, then select **Security** from the categories listed on the left of the screen.

Find **Set Supervisor Password** and enter a password to enable this feature. Once you have entered a password for this feature, you may then enable/disable **Password on Boot**.

Remember to select **F10** to properly save and exit the BIOS utility when you are done making changes.

# POWER MANAGEMENT

This computer has a built-in power management unit that monitors system activity. System activity refers to any activity involving one or more of the following devices: keyboard, mouse, hard disk, peripherals connected to the computer, and video memory. If no activity is detected for a period of time, the computer stops some or all of these devices in order to conserve energy.

## Saving power

### *Disable Fast startup*

Your computer uses Fast startup to start quickly, but also uses a small amount of power to check for signals to start. These checks will slowly drain your computer's battery.

If you prefer to reduce your computer's power requirements and environmental impact, turn off Fast startup:



#### **Note**

*If Fast startup is off, your computer will take longer to start from Sleep.*

*Your computer will also not start if it receives an instruction to start over a network (Wake on LAN).*

1. Open the desktop.
2. Click **Power Options** in the Notification area.
3. Select **More Power Options**.
4. Select **Choose what the power buttons do**.



## 5. Select Change settings that are currently unavailable.

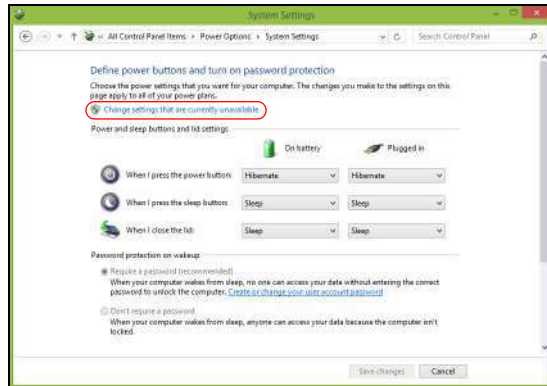

## 6. Scroll down and disable Turn on fast startup.

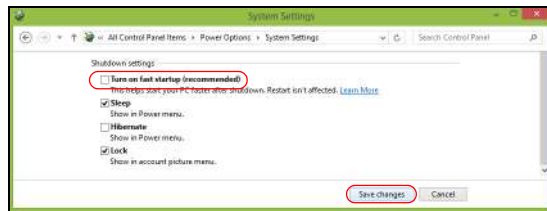

## 7. Select Save changes.

# BATTERY PACK

---

The computer uses an embedded Lithium battery that gives you long use between charges.

## Battery characteristics

The battery is recharged whenever you connect the computer to the AC adapter. Your computer supports charge-in-use, enabling you to recharge the battery while you continue to operate the computer. However, recharging with the computer turned off significantly reduces charge time.

The battery will come in handy when you travel or during a power failure.

## Charging the battery

Plug the AC adapter into the computer, and connect to a mains power outlet.



### Note

*You are advised to charge the battery before retiring for the day. Charging the battery overnight before traveling enables you to start the next day with a fully charged battery.*

### Conditioning a new battery pack

Before you use a battery pack for the first time, there is a conditioning process that you should follow:

1. Connect the AC adapter and fully charge the battery.
2. Turn on the computer and complete setting up the operating system.
3. Disconnect the AC adapter.
4. Operate the computer using battery power.
5. Reconnect the AC adapter and fully charge the battery again.

Follow these steps again until the battery has been charged and discharged three times.

Use this conditioning process for all new batteries, or if a battery hasn't been used for a long time.



### **Warning**

**Do not expose battery packs to temperatures below 0° C (32° F) or above 45° C (113° F). Extreme temperatures may adversely affect the battery pack.**

The battery conditioning process ensures your battery accepts the maximum possible charge. Failure to follow this procedure will prevent you from obtaining the maximum battery charge, and will also shorten the effective lifespan of the battery.

In addition, the useful lifespan of the battery is adversely affected by the following usage patterns:

- Using the computer on constant AC power.
- Not discharging and recharging the battery to its extremes, as described above.
- Frequent use; the more you use the battery, the faster it will reach the end of its effective life. An embedded battery has a life span of more than 1,000 charge/discharge cycles.

## **Optimizing battery life**

Optimizing battery life helps you get the most out of battery operation, prolonging the charge/recharge cycle and improving recharging efficiency. You are advised to follow the suggestions set out below:

- Use AC power whenever possible, reserving battery for mobile use.
- Remove accessories that are not being used (e.g. a USB disk drive), as they can continue to draw power.
- Store your PC in a cool, dry place. The recommended temperature is 10° C (50° F) to 30° C (86° F). Higher temperatures cause the battery to self-discharge faster.

- Excessive recharging decreases the battery life.
- Look after your AC adapter and battery.

## Checking the battery level

The power meter indicates the current battery level. Rest the cursor over the battery/power icon on the taskbar to see the battery's present charge level.

## Battery-low warning

When using battery power pay attention to the power meter.



### Important

Connect the AC adapter as soon as possible after the battery-low warning appears. Data may be lost if the battery is allowed to become fully depleted and the computer shuts down.

When the battery-low warning appears, the recommended course of action depends on your situation:

Situation	Recommended Action
The AC adapter and a power outlet are available.	1. Plug the AC adapter into the computer, and then connect to the main power supply. 2. Save all necessary files. 3. Resume work. <b>Turn off the computer if you want to recharge the battery rapidly.</b>
The AC adapter or a power outlet is unavailable.	1. Save all necessary files. 2. Close all applications. 3. Turn off the computer.



# TRAVELING WITH YOUR COMPUTER

---

This section gives you tips and hints to consider when moving around or traveling with your computer.

## Disconnecting from the desktop

Follow these steps to disconnect your computer from external accessories:

1. Save any open files.
2. Remove discs from optical drive.
3. Shut down the computer or put it into Sleep or Hibernate mode.
4. Close the display cover.
5. Disconnect the cord from the AC adapter.
6. Disconnect the keyboard, pointing device, printer, external monitor and other external devices.
7. Disconnect the Kensington lock if you are using one to secure the computer.

## Moving around

When you are just moving within short distances, for example, from your office desk to a meeting room.

## Preparing the computer

Before moving the computer, close and latch the display cover to place it in Sleep mode. You can now safely take the computer anywhere you go within the building. To wake the computer from Sleep mode, open the display and, if necessary, press and release the power button.

If you are taking the computer to a client's office or a different building, you may choose to shut down the computer:

Press the *Windows key* + **C**, click **Settings** > **Power** then click **Shut Down**

Or:

You can put the computer in Sleep mode by pressing the Sleep hotkey or by closing the display.

When you are ready to use the computer again, open the display and, if necessary, press and release the power button.



### Note

*The computer may enter Hibernation or Deep Sleep mode after being in Sleep mode for a period of time.*

## What to bring to meetings

If your meeting is relatively short, you probably do not need to bring anything with you other than your computer. If your meeting will be longer, or if your battery is not fully charged, you may want to bring the AC adapter with you to plug in your computer in the meeting room.

If the meeting room does not have an electrical outlet, reduce the drain on the battery by putting the computer in Sleep mode. Press the Sleep hotkey or close the display cover whenever you are not actively using the computer.

## Taking the computer home

When you are moving from your office to your home or vice versa.

## Preparing the computer

After disconnecting the computer from your desktop, follow these steps to prepare the computer for the trip home:

- Check that you have removed all media and compact discs from the drive(s). Failure to remove the media can damage the drive head.

- Pack the computer in a protective case that can prevent the computer from sliding around and cushion it if it should fall.

**Warning**

**Avoid packing items next to the top cover of the computer. Pressure against the top cover can damage the screen.**

## What to take with you

Unless you have some items at home, take the following items with you:

- AC adapter and power cord.
- The printed *Setup Guide*.

## Special considerations

Follow these guidelines to protect your computer while traveling to and from work:

- Minimize the effects of temperature changes by keeping the computer with you.
- If you need to stop for an extended period of time and cannot carry the computer with you, leave the computer in the trunk of the car to avoid exposing the computer to excessive heat.
- Changes in temperature and humidity can cause condensation. Allow the computer to return to room temperature, and inspect the screen for condensation before turning on the computer. If the temperature change is greater than 10° C (18° F), allow the computer to come to room temperature slowly. If possible, leave the computer for 30 minutes in an environment with a temperature between outside and room temperature.

## Setting up a home office

If you frequently work on your computer at home, you may want to purchase a second AC adapter for use at home. With

a second AC adapter, you can avoid carrying the extra weight to and from home.

If you use your computer at home for significant periods of time, you might also want to add an external keyboard, monitor or mouse.

## Traveling with the computer



### **Important**

**Check with your airline for any special requirements for travelling with Lithium batteries.**

When you are moving within a larger distance, for instance, from your office building to a client's office building or traveling locally.

## Preparing the computer

Prepare the computer as if you were taking it home. Make sure that the battery in the computer is charged. Airport security may require you to turn on your computer when carrying it into the gate area.

## What to take with you

Take the following items with you:

- AC adapter
- Additional printer driver files if you plan to use another printer

## Special considerations

In addition to the guidelines for taking the computer home, follow these guidelines to protect your computer while traveling:

- Always take the computer as carry-on luggage.

- If possible, have the computer inspected by hand. Airport security X-ray machines are safe, but do not put the computer through a metal detector.

## Traveling internationally



### **Important**

**Check with your airline for any special requirements for travelling with Lithium batteries.**

When you are moving from country to country.

## Preparing the computer

Prepare the computer as you would normally prepare it for traveling.

## What to bring with you

Bring the following items with you:

- AC adapter.
- Power cords that are appropriate for your destination(s).
- Additional printer driver files if you plan to use another printer.
- Proof of purchase, in case you need to show it to customs officials.
- International Travelers Warranty passport.

## Special considerations

Follow the same special considerations as when traveling with the computer.

In addition, these tips are useful when traveling internationally:

- When traveling in another country, check that the local AC voltage and the AC adapter power cord specifications are compatible. If not, purchase a power cord that is

compatible with the local AC voltage. Do not use converter kits sold for appliances to power the computer.

- If you are using the modem, check if the modem and connector are compatible with the telecommunications system of the country you are traveling in.

# Ports and connectors...

## **In this section you will find:**

- Information on the ports and connectors fitted to your computer

# UNIVERSAL SERIAL BUS (USB)

The USB port is a high-speed port which allows you to connect USB peripherals, such as a mouse, an external keyboard, additional storage (external hard disks), or any other compatible device.

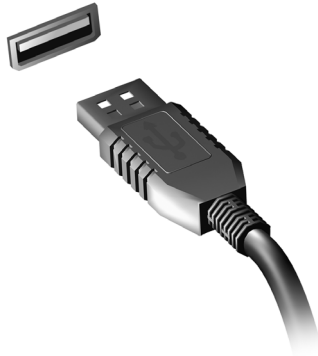

## Note

*Two USB standards are currently available on Predator computers: USB 2.0 (High-speed USB) and USB 3.0 (SuperSpeed USB). USB 2.0 ports on Predator computers have a black tongue in the port, while USB 3.0 ports have a blue tongue. For best performance, USB 3.0 devices should always be plugged into USB 3.0 ports. Consult your device's documentation to see which standard it supports.*

You can also charge devices such as tablets, smartphones, or other devices through a USB port. Some USB 3.0 ports support charging devices when the computer is in Hibernate or turned off. Additionally, you can use a USB hub to connect multiple devices to a single USB port.



## Important

**When removing a USB storage device, you should right-click on the USB icon in the Windows task bar and select "Eject <device>" to tell the operating system to stop using the device before removing it. Failure to do this may result in data loss or damage to your peripheral.**



# USB TYPE-C PORT

A USB Type-C port is a connector that allows you to easily connect USB Type-C peripherals, such as additional storage (e.g. an external drive), or any other compatible device.

The Type-C port is reversible; connectors may be inserted with either side up.

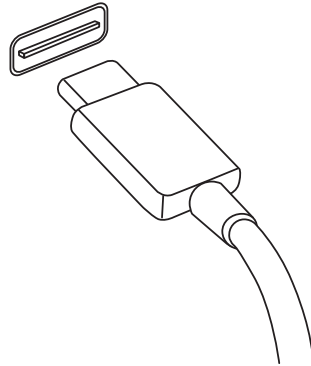

## Note

*On Acer computers USB Type-C ports support up to USB 3.1 (SuperSpeed USB, 5 Gbps).*

*Other USB or Thunderbolt devices with a USB Type-C connector are supported, but transfer speed may be reduced and certain functions will be disabled (such as Thunderbolt video support).*



## Important

**When removing a USB storage device, you should right-click on the USB icon in the Windows task bar and select "Eject <device>" to tell the operating system to stop using the device before removing it. Failure to do this may result in data loss or damage to your peripheral.**

# SD CARD READER

SD (Secure Digital) cards are used in a wide selection of digital cameras, tablets, media players and cellular phones.



## Inserting an SD card

1. Align the card so that the connector points towards the port, with the connectors facing down.
2. Carefully slide the card into the port. If you find you need to use any force to insert the card, try reorientating the card slightly.
3. Push the card until it clicks into place. A few millimetres of the card will extend from beyond the slot.

If the card contains some files, the *Windows AutoPlay* window may appear (this depends on the contents of the card) and ask you if you wish to use a program to access the contents of the card.



### **Important**

When removing an SD card, you should right-click on the USB icon in the Windows task bar and select "Eject <card name>" to tell the operating system to stop using the device before removing it. Failure to do this may result in data loss or damage to your peripheral.

## SD, SDHC and SDXC cards

Different types of SD cards cover different capacities, while using the same overall design. SD cards contain up to 4 GB; SDHC cards contain up to 32 GB; and SDXC cards can contain up to 2048 GB (2 TB). Your computer provides an SDHC or SDXC compatible card reader.



### **Note**

*SDXC memory cards can only be used in an SDXC-compatible reader; SD and SDHC cards can be used in either type.*

# VIDEO AND AUDIO CONNECTORS

---

Add an external monitor to your computer via a video port. The type of port available depends on your computer's configuration.

## Connecting a monitor

1. Check that the computer is powered off and the monitor power switch is turned off.
2. Attach the video cable to the monitor port on the computer.
3. Connect the monitor power cable and plug it into a properly grounded wall outlet.
4. Follow any setup instructions in the monitor's user's guide.
5. Turn on power to the monitor, then the computer.
6. The correct resolution and refresh rate should be detected automatically. If necessary, change the display settings used by the computer.



### Note

*To access the display controls, press the Windows key [⊞] + W, type "Display" and then click on **Display**.*

## Headphones and microphone

One or more 3.5 mm jacks on your computer allow you to connect audio devices.

Use the headphone port to plug in stereo headphones or powered speakers; connecting an audio device to the headphone port disables the built-in speakers.

Use the microphone port to connect an external microphone; connecting a microphone disables the built-in microphone.



### Note

*Some computers have a single "combo" port that allows you to use single-pin headsets with a built-in microphone. These headsets are most commonly used with smartphones.*

# HDMI

---

HDMI (High-Definition Multimedia Interface) is a high-quality, digital audio/video interface. HDMI allows you to connect any compatible digital audio/video source, such as your computer, a set-top box, DVD player, and audio/video receiver to any compatible digital audio and/or video monitor, such as a digital television (DTV) with a single cable. The single cable keeps everything neat and tidy while ensuring easy connection and the best audio and visual quality.

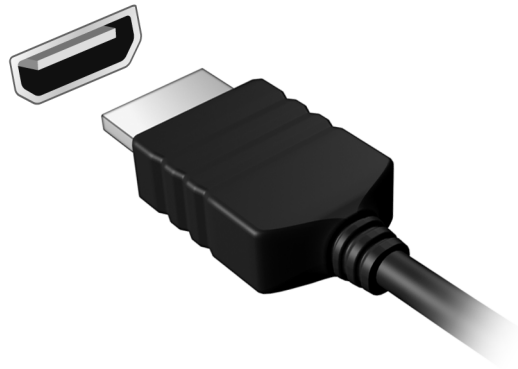

# Got a question?

## **In this section you will find:**

- Frequently asked questions
- Tips for using Windows 10
- Troubleshooting information
- How to protect yourself while online
- Where to find Predator service center contact information

# FREQUENTLY ASKED QUESTIONS

---

The following is a list of possible situations that may arise during the use of your computer. Easy solutions are provided for each one.

*I turned on the power, but the computer does not start or boot up.*

Check if power is being supplied to the computer (if your computer has a power indicator, it will be off); if there is no power, check the following:

- If you are using on the battery, it may be low and unable to power the computer. Connect the AC adapter to recharge the battery pack. You may need to wait a few minutes before trying to turn your computer on again.
- Make sure that the AC adapter is properly plugged into the computer and to the power outlet.

If power is being supplied to the computer, check the following:

- Do you have a USB storage device (USB drive, CD drive or smartphone) plugged into your computer? Unplug it and press **Ctrl + Alt + Del** to restart the system.

*Nothing appears on the screen.*

The computer's power management system automatically blanks the screen to save power. Press any key to turn the display back on.

If pressing a key does not turn the display back on, three things might be the cause:

- The brightness level might be too low. Use the *Brightness up* hotkey to adjust the brightness level.
- The display device might be set to an external monitor. Press the display toggle hotkey to toggle the display back to the computer.

- The computer may be in Sleep or Hibernate mode (if there is a power LED, it will flash). Press and release the power button to resume.

*No audio is heard from the computer.*

Check the following:

- The volume may be muted. Look at the volume control (speaker) icon in the taskbar. If it is crossed-out, click the icon and deselect the **Mute all** option.
- The volume level may be too low. Check the volume from the volume control (speaker) icon in the taskbar. You can also use the volume control hotkeys to adjust the volume.
- If headphones, earphones or external speakers are connected to the headphone jack on the computer, the internal speakers automatically turn off.

*The keyboard does not respond.*

Try attaching an external keyboard to a USB port on the computer. If it works, contact your dealer or an authorized service center as the internal keyboard cable may be loose.

*The printer does not work.*

- Make sure that the printer is connected to a power outlet and that it is turned on.
- Make sure that the printer cable is connected securely to a USB port and the corresponding port on the printer.

*I want to restore my computer to its original settings.*



**Note**

*If your system is the multilingual version, the operating system and language you choose when you first turn on the system will be the only option for future recovery operations.*

This recovery process helps you restore the C: drive with the original software content that is installed when you purchased your computer.



### **Warning**

**Your C: drive will be reformatted and all data will be erased. It is important to back up all data files before using this option.**

Before performing a restore operation, please check the BIOS settings.

1. Check to see if **Predator disk-to-disk recovery** is enabled or not.
2. If there is a **D2D Recovery** setting in **Main**, make sure it is **Enabled**.
3. Exit the BIOS utility and save changes. The system will reboot.



### **Note**

*To access the BIOS utility, press **F2** when you see the Predator logo during boot up.*

For more information, see **Restoring your computer on page 24**.

## **Requesting service**

### *International Travelers Warranty (ITW)*

Your computer is backed by an International Travelers Warranty (ITW) that gives you security and peace of mind when traveling. An ITW passport came with your computer and contains all you need to know about the ITW program. A list of available, authorized service centers is in this handy booklet. Read this passport thoroughly.

Always have your ITW passport on hand, especially when you travel, to receive the benefits from our support centers. Attach your proof-of-purchase to the ITW passport.

If the country you are traveling in does not have an Predator-authorized ITW service site, you can still get in contact with our offices worldwide. Please visit **[www.acer.com](http://www.acer.com)**.



## *Before you call*

Please have the following information available when you call Predator for online service, and please be at your computer when you call. With your support, we can reduce the amount of time a call takes and help solve your problems efficiently. If there are error messages or beeps reported by your computer, write them down as they appear on the screen (or the number and sequence in the case of beeps).

You are required to provide the following information:

Name:

Address:

Telephone number:

Machine and model type:

Serial number:

Date of purchase:

## Tips and hints for using Windows 10

We know this is a new operating system that will take some getting used to, so we've created a few pointers to help you get started.

### How do I get to *Start*?

Press the Windows key or select the *Windows Start button* on the lower left-hand corner of the screen.

#### *Where's the Start button?*

The Start button will appear in the desktop taskbar. Selecting it will open *Start* where you can launch apps.

#### *How do I see all of my apps?*

Press the Windows key or select the *Windows Start button* and select **All apps** to show a list of installed apps on the computer.

### How do I turn off my computer?

Press the Windows key or select the *Windows Start button* and select the power icon > **Shut down**. You can also turn off the computer by right-clicking the *Windows Start button* > **Shut down or sign out** > **Shut down**.

#### *Can I turn off notifications?*

You can turn off notifications so that you can leave your computer running, but not be disturbed by notifications.

Press the Windows key or select the *Windows Start button* and select **Settings** > **System** > **Notifications & actions**. From here you can enable/disable notifications for all of your apps or choose which apps to enable/disable.

## How do I unlock my computer?

Press the space bar and select a user account icon to unlock the computer. If your account has a password set, you will need to enter the password to continue.

### *Can I personalize the Lock screen?*

You can personalize the lock screen with a different image, to run a slideshow of images, or to show you quick status and notifications to suit your personal needs.

To change the background, press the Windows key or select the *Windows Start button* and select **Settings** > **Personalization**. From here you can:

- Select a background image for the lock screen
- Turn the *Slide show* on or off
- Select lock screen apps.

### *How do I set up the lock screen slideshow?*

1. Press the Windows key or select the *Windows Start button* and select **Settings** > **Personalization**.
2. Under Background, select *Slideshow*.
3. Select **Add a folder** and open the folder you wish to use [your *Pictures* folder will open by default]. Select **Choose this folder** to add the folder to the lock screen slideshow.
4. Select a folder and select **Remove** to remove the folder from the lock screen slideshow.
5. Change the other settings to suit your needs.

### *How do I move tiles?*

Select a tile and drag it to the place on *Start* that you want it to appear. Other tiles will be moved to accommodate the tile in its new location.

### *Can I arrange tiles in groups?*

Yes, you can. Select an existing tile and drag the tile to arrange *Start* to your liking. Right-click on an app and select **Pin to Start** to create a new group on *Start*. From here, you

can drag the tile to an existing group on *Start*. You can give the group(s) a name and arrange the tiles within the groups to suit your needs.

### *Can I make tiles bigger or smaller?*

Yes, you can. Right-click on a tile and select **Resize**. Select a size from the menu that appears.

### *Can I change the screen resolution?*

Yes, you can. Move your cursor to the lower left-hand corner of the screen and type 'Control Panel' in the text box to display the results; select **Control Panel > Adjust screen resolution**. Alternatively, you can also right-click anywhere on the desktop and select **Screen resolution**.

## **How do I set the alarm?**

Your computer can act as an alarm clock. Type 'Alarms' to search for the *Alarms & Clock* app.

1. Select an alarm from the list, or select the + in the lower-right corner to create a new alarm.
2. Enter the *Alarm name*.
3. Set the time by choosing the hour and minute.
4. Select AM or PM.
5. Choose which days the alarm should go off.
6. Select the sound notification.
7. Select the snooze time.
8. Select the *Save* icon in the bottom right-hand corner to save the alarm.

## 9. Select *On* or *Off* to activate or deactivate the alarm.

The screenshot shows the 'Alarms & Clock' application window. At the top, it says 'EDIT ALARM'. Below this is a table for setting the alarm time:

4	58	
5	59	
6	00	AM
7	01	PM
8	02	
9	03	
10	04	
11	05	
12	06	
1	07	
2	08	
3	09	
4	10	
5	11	
6	12	

Below the table, it says 'In 20 hours, 36 minutes'. Underneath, there are settings for the alarm: 'Alarm name: Good morning', 'Repeats: Every day', 'Sound: Chimes', and 'Snooze time: 10 minutes'. At the bottom right, there are 'Save' and 'Delete' buttons.



### Note

*The alarm will only sound if your computer is awake at the set time.*

## Where are my apps?

Move your cursor to the lower left-hand corner of the screen and select **Search**, start typing the name of the app you would like to open.

### *How do I make an app appear on Start?*

If you're in *All apps* and you want to make an app appear on *Start*, right-click an app and select **Pin to Start**.

### *How do I remove a tile from Start?*

Right-click a tile to select it and select **Unpin from Start** to remove the tile from *Start*.

### *How do I make an app appear on my taskbar?*

If you're in *All apps* and you want to make an app appear on the taskbar, right-click an app or tile and select **Pin to taskbar**.

### *How do I install apps?*

You can download Windows Store apps from *Store*. You will need to have a Microsoft ID to purchase and download apps from *Store*.

### *I can't find apps like Notepad and Paint! Where are they?*

Move your cursor to the lower left-hand corner of the screen and select **Search**. Type the name of the app you would like to open. Alternatively, open *All apps* and scroll to 'Windows Accessories' to see the list of legacy programs.

## **What is a Microsoft ID (account)?**

A Microsoft account is an email address and password that you use to sign in to Windows. You can use any email address, but it is best if you choose the one you already use to communicate with friends and sign in to your favorite websites. When you sign in to your PC with a Microsoft account, you'll connect your PC to the people, files, and devices you care about.

### *Do I need one?*

You do not need a Microsoft ID to use Windows 10, but it makes life easier because you can sync data across different machines you sign in to using a Microsoft ID.

### *How do I get one?*

If you've already installed Windows 10 and didn't sign in with a Microsoft account or you don't have a Microsoft account and want to get one, press the Windows key or select the *Windows Start button* > **Settings** > **Accounts** > **Sign in with a Microsoft account**, and follow the onscreen instructions.

## **How do I check for Windows updates?**

Press the Windows key or select the *Windows Start button* > **Settings** > **Update & recovery** > **Windows Update**. Select **Advanced options** to configure the settings.

## Where can I get more information?

For more information please visit the following pages:

- Windows 10 information: [go.acer.com/windows-tutorial](https://go.acer.com/windows-tutorial)
- Support FAQs: [support.acer.com](https://support.acer.com)

# Troubleshooting

This chapter shows you how to deal with common system problems.

Read it before calling a technician if a problem occurs. Solutions to more serious problems require opening up the computer. Do not attempt to open the computer yourself; contact your dealer or authorized service center for assistance.

## Troubleshooting tips

This computer incorporates an advanced design that delivers onscreen error message reports to help you solve problems.

If the system reports an error message or an error symptom occurs, see "Error messages" below. If the problem cannot be resolved, contact your dealer.

## Error messages

If you receive an error message, note the message and take the corrective action. The following table lists the error messages in alphabetical order together with the recommended course of action.

Error messages	Corrective action
CMOS battery bad	Contact your dealer or an authorized service center.
CMOS checksum error	Contact your dealer or an authorized service center.
Disk boot failure	Insert a system (bootable) disk, then press <b>Enter</b> to reboot.
Equipment configuration error	Press <b>F2</b> (during POST) to enter the BIOS utility, then press <b>Exit</b> in the BIOS utility to reboot.
Hard disk 0 error	Contact your dealer or an authorized service center.



Error messages	Corrective action
Hard disk 0 extended type error	Contact your dealer or an authorized service center.
I/O parity error	Contact your dealer or an authorized service center.
Keyboard error or no keyboard connected	Contact your dealer or an authorized service center.
Keyboard interface error	Contact your dealer or an authorized service center.
Memory size mismatch	Press <b>F2</b> (during POST) to enter the BIOS utility, then press <b>Exit</b> in the BIOS utility to reboot.

If you still encounter problems after going through the corrective measures, please contact your dealer or an authorized service center for assistance.

# INTERNET AND ONLINE SECURITY

---

## First steps on the net

### Protecting your computer

It is vital to protect your computer from viruses and attacks over the internet (**see Internet security software on page 78**).

A comprehensive internet security program is offered when you first start your computer. You should activate this protection as soon as possible, certainly before you connect to the internet.

### Choose an Internet Service Provider



Using the internet has become a natural part of daily computing. Just a few simple steps can connect you to a vast collection of knowledge and communication tools. To accomplish these steps you should first select an *Internet Service Provider* (ISP), which supplies the connection between your computer and the internet. You should research the ISPs available in your region, not forgetting to talk to friends and family about their experiences or to check reviews and consumer reports. The ISP you select will provide instructions on how to connect to the internet (you may need additional software or a special 'box' that connects to your phone line).

### *Connection types*

Depending on your computer model, your location and your communication needs, you have several ways to connect to the internet.

## Dial-up

Some computers include a telephone dial-up ('modem') connector. This allows you to connect to the internet using your telephone line. With a dial-up connection, you cannot use the modem and the telephone simultaneously on a single phone line. This type of connection is recommended only if you have limited use of the internet as the connection speed is low and connection time is typically charged per hour.

## DSL (e.g. ADSL)

DSL (Digital Subscriber Line) is an 'always-on' connection that runs over the phone line. As DSL and phone do not use the same frequencies, you can use your telephone at the same time you are connected to the internet (this requires a 'micro-filter' on each telephone socket to avoid interference). To be eligible for DSL, you must be located near an DSL-equipped phone exchange (service is sometimes unavailable in rural areas). Connection speeds vary depending on your location, but DSL generally provides very fast and reliable internet connection. As the connection is always-on, it is generally charged at fixed monthly rates.



### **Note**

*A DSL connection requires an appropriate modem. A modem is usually provided by the ISP when you register. Many of these modems include an 'router' that provides network and Wi-Fi access.*

## Cable

A cable connection provides fast and always-on internet service via a cable television line. This service is generally available in large cities. You can use your telephone and watch cable TV at the same time you are connected to the internet.

## Cellular

A cellular connection allows you to use cellular networks (such as those used by a mobile phone) to connect to the

internet while away from home. The socket for a SIM card may be built in to your computer, or may require an external device, such as a USB modem or even an appropriately equipped mobile phone.



### Note

*If your computer includes a SIM card slot, you require a compatible SIM card and a contract with a cellular provider. Before using the cellular features, check with your service provider to see if any additional charges will be incurred, especially roaming charges.*

## Network connections

A LAN (Local Area Network) is a group of computers (for example, within an office building or home) that share a common communications line and resources. When you set up a network, you can share files, peripheral devices (such as a printer) and an internet connection. You can set up a LAN using wired technologies (such as Ethernet) or wireless technologies (such as Wi-Fi or Bluetooth).

### *Wireless networks*

A wireless LAN or WLAN is a wireless local area network, which may link two or more computers without using wires. Setting up a wireless network is easy and allows you to share files, peripheral devices and an internet connection.

### What are benefits of a wireless network?

#### *Mobility*

Wireless LAN systems allow you and other users of your home network to share access to files and devices connected to the network, for example a printer or scanner.

Also you can share an internet connection with other computers in your home.

#### *Installation speed and simplicity*

Installing a wireless LAN system can be fast and easy and eliminates the need to pull cables through walls and ceilings.

## Components of a wireless LAN

To set up your Wireless network at home you need to have the following:

### Access point [router]

Access points [routers] are two-way transceivers that broadcast data into the surrounding environment. Access points act as a mediator between wired and wireless network. Most routers have a built-in DSL modem that will allow you access to a high speed DSL internet connection. The ISP (Internet Service Provider) you have chosen normally supplies a modem/router with the subscription to their services. Read carefully the documentation supplied with your Access point/router for detailed setup instructions.

### Network cable [RJ45]

A network cable (also called RJ45 cable) is used to connect the host computer to the access point (see illustration below); this type of cable may also be used to connect peripheral devices to the access point.

### Wireless adapter

Most computers feature a wireless module and Wi-Fi button that turns the network connection on or off. You may also turn your wireless network on or off, or control what is shared over the network with the network management options. Search 'HomeGroup' and then click on **HomeGroup**.



#### **Warning**

**Using wireless devices while flying in aircraft may be prohibited. Switch off all devices before boarding an aircraft; they may be dangerous to the operation of the aircraft, disrupt communications, and even be illegal. After take off, ask the cabin crew if you may enable Wi-Fi.**

## Surf the Net!

To surf the internet, you need a program called an internet browser. *Microsoft Edge* provides an easy and secure web browsing experience. As soon as you have your internet access installed and you are connected, from the Start Menu, click the Microsoft Edge tile or the icon located in the taskbar and take your internet experience to a new level!



### *Predator website*

To get you started why not visit our website, **www.acer.com**. Predator is dedicated to provide you with on-going personalized support. Check out our *Support* section to get help tailored to your needs.

**www.acer.com** is your portal to a world of online activities and services: visit us regularly for the latest information and downloads!

## Internet security software

To help you stay ahead of cybercriminals, Acer has partnered with Norton to offer you security for all your devices.

*Select Acer computers include protection by Norton Security*

Norton Security is pre-installed on select Acer computers, protecting your identity and financial data from viruses, spyware, malware and other online threats. Learn more about how to stay safe online and how to stay protected after your introductory subscription ends.

### *Staying ahead of cybercriminals*

Stay ahead of hackers and cybercriminals by understanding the tactics they use to access your private data.

### Ensure your software is up to date

Cybercriminals rely heavily upon software or platform vulnerabilities, as they are the easiest way to sneak malware into a user's device unnoticed, sometimes with little action on the user's part. Immediately after a software manufacturer announces an update, hackers are ready with malware that can breach holes in the software that would have been patched if the update was installed.

**How to stay safe:** Perform any and all software updates as soon as they are available.

### Keep a lookout for fake or phishing emails

Beware of emails that appear to be from a friend or business colleague that you know but seem a little odd. Maybe they didn't capitalize your name or there are misspellings. The email might be from cybercriminals who are trying to fool you into sending them your credit card number, social security number, or logging into a fake bank website that looks like yours but really isn't.

**How to stay safe:** Use a strong antispam filter. If an email looks strange, don't click on anything and delete it immediately. Instead manually launch a browser and type in your bank's website address and log-in yourself.

### Don't be fooled if someone calls your phone

A tech support scam is a form of online fraud where people call you on the phone saying they're Technical Support from a trusted company like Norton or Microsoft and that you have a virus. The main motive behind these scams is to extort money from the victim. Cybercriminals can also install malware such as keylogging software or backdoor Trojans in order to gain access to personal information.

**How to stay safe:** Don't fall for phone calls that tell you your software or computer isn't working. Never give your personal information like social security or credit card numbers to someone that you don't know over the phone.

## *Common threats cybercriminals use*

Now you know a few very common ways cybercriminals try to sneak onto your device or trick you into providing private information to them directly. Here are a few of the types of malware they like to deploy once they've got into a device and what to do if you're ever infected.

### Ransomware

A form of malware that will encrypt personal data files on your computer and attached devices. Encryption converts files into another format, that can only be opened with a specific decryption key. Once the ransomware installs itself, it will display a warning message that the computer is now locked. The user is given a specific amount of money to pay as a "fine" and a timeframe in which to pay. Even if paid, the criminal might choose to not unencrypt the files anyway!

**What to do if you're infected:** Avoid getting infected in the first place by staying protected with internet security software like Norton Security. Also, perform regular backups of all your data either online or to a separate external hard drive that is *only attached* to your computer while performing the backup. Ransomware has been known to lock access to external hard drives attached to the computer.

If you are infected with ransomware, think twice before you pay the ransom. There is no guarantee the cybercriminal will unlock your files and you'll be funding them to prey upon another innocent victim.

### Botnets

A botnet is a string of infected, connected computers coordinated together to perform a task. Botnets gain access to your machine through some piece of malicious coding. Once the software is downloaded, the botnet will now contact its master computer and let it know that everything is ready to go. Now your computer, phone, tablet, or IoT device is entirely under the control of the person who created the botnet. Most people who are infected with



botnets aren't even aware that their computer's security has become compromised!

**What to do if you're infected:** If you're infected you probably don't realize it as bots are notoriously quiet. Your Internet Service Provider might send you a notification alerting you that they found a threat on your network and that you need to remove the bot. If you have a bot, use internet security software like Norton Security to scan all of your devices.

### Viruses/Malware

"Virus" is the commonplace word for all malicious software programs for years now; however, a virus is just one type of malicious threat. A virus is classified as a self-replicating piece of malicious code that travels by inserting itself into files or programs.

**What to do if you're infected:** Take steps to avoid infection by staying protected with internet security software like Norton Security. If you subscribed to Norton Security and think you may have a virus, contact Norton's on-call technicians to help eliminate the virus.

### *Take special precautions when using public Wi-Fi*

Public Wi-Fi is available just about everywhere, from the local coffee shop to the hotels and airports you visit while traveling. While public Wi-Fi has made our lives a little easier, it also poses security risks to the personal information available on our laptops and smartphones. A virtual private network (VPN) gives you online privacy and anonymity by creating a private network from a public internet connection. VPNs mask your internet protocol (IP) address so your online actions are virtually untraceable as well as secure. One of the biggest security risks on public Wi-Fi are man-in-the-middle attacks (MITM). These attacks are akin to eavesdropping. Data is sent from point A [computer] to point B [server/website], and an attacker can get in-between these transmissions. They then set up tools programmed to "listen in" on transmissions, intercept data

that is specifically targeted as valuable, and capture the data, such as your login credentials and passwords.

Use a virtual private network (VPN) to ensure your privacy and anonymity are protected when you use public Wi-Fi. VPN services can encrypt all the data that you send and receive while using a public Wi-Fi hotspot, securing your information from hackers and other users of the same connection.

### *For more tips on how to stay safe*

Good security habits can reduce your exposure to online crime. By adopting a few basic behaviors, you can make big strides in reducing cybercrime risk:

- Protect your accounts with strong, unique passwords that use a combination of at least 10 uppercase and lowercase letters, symbols and numbers.
- Don't click on random links or open unsolicited messages and attachments—particularly from people you don't know.
- Don't access any personal information or social media accounts over unprotected Wi-Fi networks.
- Use security software on your devices to help protect yourself from the latest threats.

### *Protect your computer with Windows security tools*

Windows provides a variety of protection applications.

#### Windows Updates

If you have an active internet connection, Windows can check for important updates for your computer and install them automatically. These updates include security patches and program updates that can improve your computing experience and help protect your computer against new viruses and attacks.

#### How do I know when my computer is at risk?

If the *Action Center* reports an alert, or if your computer behaves erratically, crashes unexpectedly or if some of your programs do not work correctly, your computer may be

infected by malicious software. However, do not blame every computer problem on a virus! If you suspect your computer is infected, the first thing to do is update, if you have not already done so, and run your antivirus and anti-spyware software.