

FRIGIDAIRE

33 LBS

15 KGS

ICE MAKER

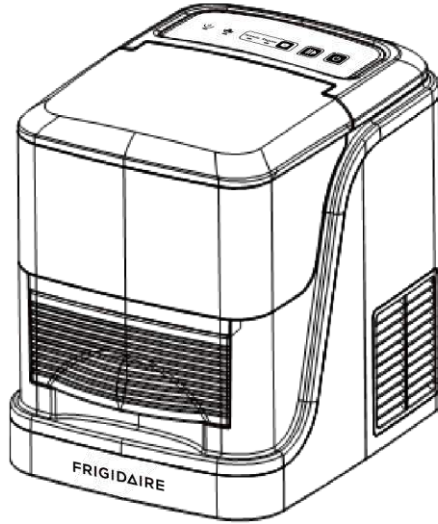

TABLE OF CONTENTS

IMPORTANT SAFEGUARDS.....	1
TECHNICAL PARAMETERS.....	3
KNOW YOUR ICE MAKER.....	3
USE YOUR ICE MAKER.....	6
CLEANING AND MAINTENANCE.....	8
TROUBLESHOOTING	8
WARNING.....	10

* This ice maker is not designed to keep ice frozen. After each use, remove all ice cubes, drain the water.

FRIGIDAIRE is a pending or registered trademark used under license from Electrolux Home Products, Inc.

For service assistance and product information, please call: 1-800-968-9853.
Curtis International Ltd.
7045 BECKETT DRIVE, UNIT 15, MISSISSAUGA, ON, L5S 2A3 www.curtisint.com

USER MANUAL

IMPORTANT SAFEGUARDS:

When using an electrical appliance, basic safety precautions should always be followed to reduce the risk of fire, electric shock, and/or injury, including the following:

1. Read all instructions before using.
2. Remove all packing material and carefully check your ice maker to ensure it is in good condition and that there is no damage to the ice maker or power cord and plug.
3. Before using the ice maker for the first time, please wait 2 hours after positioning it, and keep the transparent lid open for at least 2 hours
4. Pure water is not allowed to be used on this unit, spring water is recommended.
5. Ensure the voltage is compliant with the voltage range stated on the rating label, and ensure the earthing of the socket is in good condition.
6. If the supply cord is damaged, it must be replaced by the manufacturer or its service agent or a similarly qualified person in order to avoid a hazard.
7. Do not upend this product or incline it over a 45° angle.
8. To protect against risk of electric shock, do not pour water on cord, plug and ventilation, immerse the appliance in water or any other liquid.
9. Unplug the appliance after using or before cleaning.
10. Keep the appliance 15cm from other objects to ensure the good heat releasing.
11. Component parts shall be replaced with like components and that servicing shall be done by factory authorized service personnel, to minimize the risk of possible ignition due to incorrect parts or improper service.
12. This appliance can be used by children aged from 8 years and above and persons with reduced physical, sensory or mental capabilities or lack of experience and knowledge if they have been given supervision or instruction concerning use of the appliance in a safe way and understand the hazards involved. Children shall not play with the appliance. Cleaning and user maintenance shall not be made by children without supervision. Children should be supervised to ensure that they do not play with the appliance.

13. Do not use the appliance close by flames, hot plates or stoves.
14. Do not switch on the power button frequently (ensure 5min. interval at least) to avoid the damage of compressor.
15. Metal sheet or other electric objects are not allowed to be inserted into the appliance to avoid fire and short circuit.
16. Do not use outdoors.
17. Never clean with scouring powders or hard implements.
18. Please keep the instruction manual.
19. Warning: Do not store explosive substances such as aerosol cans with a flammable propellant in this appliance.
20. This appliance is intended to be used in household and similar applications such as
 - staff kitchen areas in shops, offices and other working environments;
 - farm houses and by clients in hotels, motels and other residential type environments;
 - bed and breakfast type environments;
 - catering and similar non-retail applications.
21. The refrigerant and insulation blowing gas is flammable, when disposing of the appliance, do so only at an authorized waste disposal centre. Do not expose to flame.



Is fire warning sign. Caution risk of fire.

22. Caution: Flammable refrigerant used! When handling, moving and use of the ice maker, make sure to avoid either damaging the refrigerant tubing, or increasing the risk of a leak.
23. The ice maker is to be installed in accordance with the Safety Standard for Refrigeration Systems, ASHRAE 15.
24. The ice maker shall not be installed in corridors or hallways of public buildings.

TECHNICAL PARAMETERS:

Model Number: EFIC229-VCM

Refrigerant:R600a(23g)

Daily Ice Output: 15kg / 24 hours

N.W: 11.5kg

Ice Sizes: large ice and small ice

Voltage: AC120V / 60 Hz

Ice Storage Capacity: 600g

Power Consumption: 150 W

Water Reservoir Capacity(up): 2.5 L

Water Reservoir Capacity(down) : 1.0 L

Unit Dimensions : 357(W)X289(D)X352(H)mm

KNOW YOUR ICE MAKER:

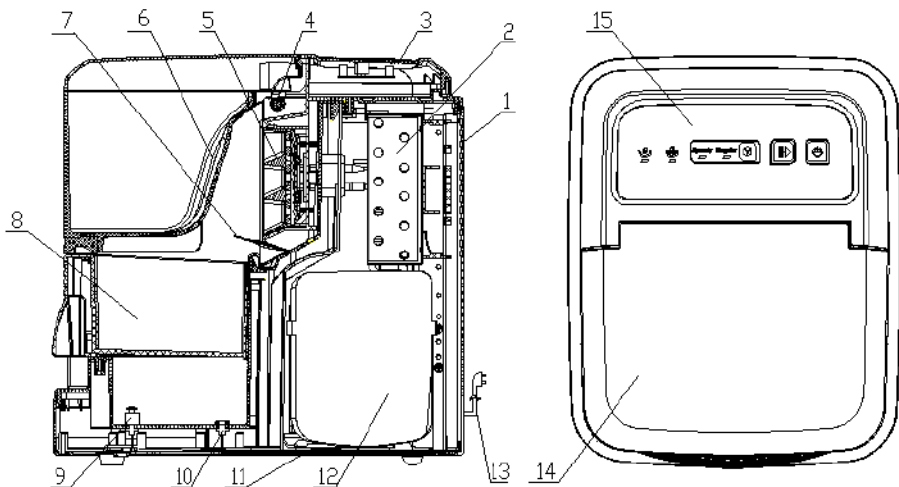

1. REAR COVER
2. CONDENSER
3. TOP COVER
4. WATER DRAIN
5. EVAPORATOR
6. TRANSPARENT WATER BOX
7. ICE BOARD
8. ICE BASKET
9. FLOATER SWITCH
10. WATER TEMPERATURE SENSOR
11. BASEBOARD
12. COMPRESSOR
13. POWER CORD
14. TRANSPARENT WATER BOX COVER
15. CONTROL PANEL

Feature:

- ✧ SPEEDY & REGULAR ICE -MAKING
- ✧ EASY-USE CONTROL DESIGN. TWO SIZES OF ICE COULD BE OPTIONAL
- ✧ TRANSPARENT DIAMOND ICE
- ✧ SPEEDY(17MIN) AND REGULAR(21MIN) ICE-MAKING CAN MAKE 24 PIECES (A BLOCK OF ICE)
- ✧ TRANSPARENT WATER TANK AND THE ICE-MAKING PROCESS IS VISIBLE.
- ✧ UNDER THE CONDITION OF AMBIENT TEMPERATURE OF 25°C, THE TIME OF MAKING BIG ICE IS 21MIN, SMALL ICE IS 17MIN.

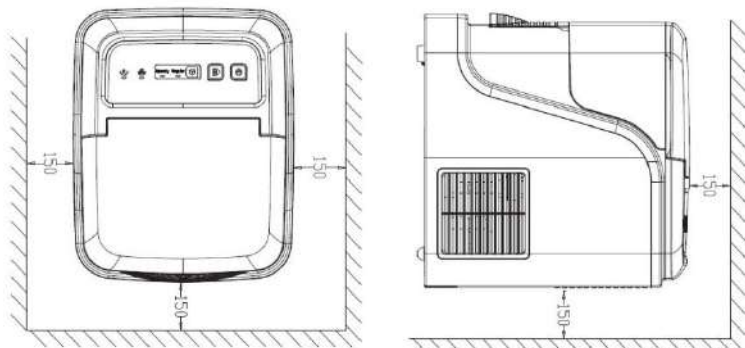

The machine should be upright to place on the horizontal plane. To ensure the machine ventilate normally, it is important to set 150mm room on top, sides and back. Do not place the machine next to the roast oven, radiate or other heat objects.

Control Panel Operation :

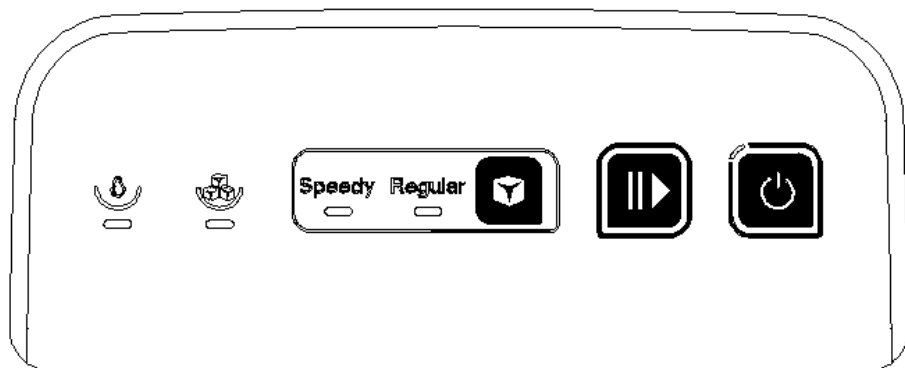



The indicator of 'POWER' will flash after plugged in, press 'POWER' and then the machine enters standby state accompanying indicator lighting. During operation, if user presses this button, the machine will return to standby state.



(Pause & start)After choose the menu, press this key, and start to work.



This button is for selecting the size of ice. When you select the desired size, corresponding indicator of Speedy or Regular will be on.



When the machine is lack of water, the indicator of this button turns to red. User need to add enough water into the reservoir and press 'POWER' button to restart the machine.



When the ice reaches to the max storage capacity, the indicator of this button will light on, and the machine will stop working. User needs to take out the ice, and then the machine will restart automatically.

USE YOUR ICE MAKER :

Step 1. Open the cover, and add water to reservoir.

Note: There is a hole on the water box, which is the maximum water level, water adding do not exceed it. If the water exceed, it will drain out.

Suggest the water add under the hole, then put the water box into

proper position, and cover it.

Step 2. Connect the power, press the  , and then the machine enters standby state.

Step 3. Select the desired ice size, the default size of machine is large one.

Step 4. Press  key to start work.

Note: The water level should not higher than the water reservoir's MAX position. If water volume goes beyond the max, please pull out drain plug under the machine bottom to drain the spare water out, and then plug the drain plug back into the drain.

Note: Please select the small ice mode when ambient temperature is below 20°C. When the ambient temperature is higher than 25°C, large ice cube sizes are recommended.

Note: Please take out the ice if the basket is full.

Note: If the ice basket is stuck by the ice, you can take out the water box first, and take out the ice from the upside, and then you can pull out the ice basket.

Note: Before making ice, do put the ice basket in the ice maker.

Cleaning & Use Guidance :

1. Clean the inner liner, ice collecting tray, water box, ice shovel and evaporator frequently. When cleaning, unplug the unit and remove the ice cubes. Use a diluted solution of water and vinegar to clean the inside and the outside surface of the Ice maker. Do not spray Ice maker with chemicals or diluted agents such as acids, gasoline or oil. Rinse thoroughly before starting.
2. Keep ventilation openings in the appliance enclosure, or in the built-in structure, clear of obstruction. Do not use mechanical devices or other means to accelerate the defrosting process, other than those recommended by the manufacturer.
3. To ensure the cleanness of ice, please change water for water reservoir at least once one day. If do not use for a long time, please drain the water out and clean it up.
4. If the compressor takes a strike action for shortage water, fully water or interruption of power supply, it will delay for 3 minutes to start up after restarted.
5. Always use fresh water before starting ice production either at initial installation or after a long shut-off period.
6. In the status of standby, press and hold the key  for 3 sec into cleaning after 5 minutes done.
7. Disassembling the water hose to clean when it is dirty or the hole is blocking.

Troubleshooting :

Please note, if a power failure occurs due to disconnection of the power cord, or the power button has been pushed off during an ice making cycle, small ice chips may formed and lodge in the automatic shovel causing it to jam. If this

occurs, press and hold the key  for 2 sec, When the ice fall, then restart the machine.

PROBLEM	POSSIBLE CAUSE	SUGGESTED SOLUTIONS
The compressor works abnormally with a buzzing Noise	The voltage is lower than recommended	Stop the Ice maker and do not restart until the voltage is normal.
Indicator light of lack of water on	<ol style="list-style-type: none"> 1. Water of Water box is not much enough 2. The ice in water box is full, but the floater switch is blocked 3. The floater is not installed right 4. The floater switch is broken 	<ol style="list-style-type: none"> 1. Add enough water to water box 2. Take out the ice 3. Take down the E circle on floater switch, reinstall the floater 4. Change the floater switch
Indicator lights on display are not on	Blown fuse/ No power	Replace fuse / Turn power on
The Ice made is too large and with pieces sticking together.	<ol style="list-style-type: none"> 1. Water temperature is too low 2. Ice of previous cycles left in the water tray 	<ol style="list-style-type: none"> 1. Select small size 2. Take out the ice under the standby state

<p>The program of making ice is correct, but no ice come out</p>	<ol style="list-style-type: none"> 1.No coolant in compressor 2. Compressor is damaged. 3. Fan motor is damaged. 	<p>Call the service center.</p>
<p>All indicators twinkle simultaneously</p>	<ol style="list-style-type: none"> 1.The ice is not access to ice board 2. The movable detect device the ice board is damaged. 	<p>Unplug the power and plug again to restart the machine.</p>
<p>The machine is on working but the water is warm</p>	<p>Electromagnetic valve is hitch</p>	<ol style="list-style-type: none"> 1.Change the electromagnetic valve
<p>The ice is full to reach the ice board, but no full indicate</p>	<ol style="list-style-type: none"> 1. The movable detect device the ice board is damaged. 2.The indicate light is damaged 	<ol style="list-style-type: none"> 1. Change The movable detect device or display board. 2. Call the service center.

WARNING

If the power cord is damaged; it must be replaced by the manufacturer, its service agent or a similarly qualified person in order to avoid a hazard.
 Fill with potable water only.

It is normal for the compressor and condenser surface to reach temperatures between 70°C and 90°C during operation and surrounding areas may be very hot.

Due to fast freezing, ice cubes may appear “Cloudy”. This is air trapped in the water and will not affect quality or taste of ice.

This appliance is not intended for use by persons (including children) with reduced physical, sensory or mental capabilities or lack of experience and knowledge unless they have been given supervision or instruction concerning use of the appliance by a person responsible for their safety.

Children should be supervised to ensure that they do not play with the appliance.

Do not immerse in water

1) Warning –the water you make ice must be drinkable.

2) Warning –keep ventilation openings, in the appliance enclosure or in the built-in structure clear of obstruction.

3) Warning – do not use mechanical devices or other means to accelerate to defrosting process ,other than those recommended by the manufacturer.

4) Warning – do not damage the refrigerant circuit.

5)Warning – do not use electrical appliance inside the food storage Compartments of the appliance ,unless they are of the type recommended by the manufacture.

Correct Disposal of this product



This marking indicates that this product should not be disposed with other household wastes throughout the EU. To prevent possible harm to the environment or human health from uncontrolled waste disposal, recycle it responsibly to promote the sustainable reuse of material resources.