

# FUJIFILM

BL00004742-100

FUJINON LENS

XF100-400mmF4.5-5.6 R LM OIS WR

## OWNER'S MANUAL

---

日本語

ENGLISH

FRANÇAIS

DEUTSCH

ESPAÑOL

NEDERLANDS

SVENSKA

NORSK

SUOMI

РУССКИЙ

ITALIANO

DANSK

POLSKI

中文簡

中文繁體

한글

عربي

## For Your Safety

Be sure to read these notes  
before use



### Safety Notes

Thank you for your purchase of this product. For repair, inspection, and internal testing, contact your FUJIFILM dealer.



- Make sure that you use the lens correctly. Read these safety notes and the camera *Owner's Manual* carefully before use.
- After reading these safety notes, store them in a safe place.





### About the Icons

The icons shown below are used in this document to indicate the severity of the injury or damage that can result if the information indicated by the icon is ignored and the product is used incorrectly as a result.

	<b>WARNING</b>	This icon indicates that death or serious injury can result if the information is ignored.
	<b>CAUTION</b>	This icon indicates that personal injury or material damage can result if the information is ignored.

The icons shown below are used to indicate the nature of the instructions which are to be observed.

	Triangular icons tell you that this information requires attention ("Important").
	Circular icons with a diagonal bar tell you that the action indicated is prohibited ("Prohibited").
	Filled circles with an exclamation mark indicate an action that must be performed ("Required").

	<b>WARNING</b>
 <i>Do not use in the bathroom or shower</i>	<b><u>Do not immerse in or expose to water.</u></b> Failure to observe this precaution can cause a fire or electric shock.
 <i>Do not disassemble</i>	<b><u>Do not disassemble (do not open the case).</u></b> Failure to observe this precaution can cause fire, electric shock, or injury due to product malfunction.
 <i>Do not touch internal parts</i>	<b><u>Should the case break open as the result of a fall or other accident, do not touch the exposed parts.</u></b> Failure to observe this precaution could result in electric shock or in injury from touching the damaged parts. Remove the camera battery immediately, taking care to avoid injury or electric shock, and take the product to the point of purchase for consultation.

 **WARNING**

 **Do not place on unstable surfaces.** The product may fall, causing injury.

 **Do not view the sun through the lens or camera viewfinders.** Failure to observe this precaution can cause permanent visual impairment.

 **CAUTION**

 **Do not use or store in locations that are exposed to steam, or smoke or are very humid or extremely dusty.** Failure to observe this precaution can cause fire or electric shock.

 **Do not leave in direct sunlight or in locations subject to very high temperatures, such as in a closed vehicle on a sunny day.** Failure to observe this precaution can cause fire.

 **Keep out of the reach of small children.** This product could cause injury in the hands of a child.

 **Do not handle with wet hands.** Failure to observe this precaution can cause electric shock.

 **CAUTION**

 **Keep the sun out of the frame when shooting backlit subjects.** Sunlight focused into the camera when the sun is in or close to the frame can cause fire or burns.

 **When the product is not in use, replace the lens caps and store out of direct sunlight.** Sunlight focused by the lens can cause fire or burns.

 **Do not carry the camera or lens while they are attached to a tripod.** The product can fall or strike other objects, causing injury.

 **Do not rapidly rotate the camera while holding the grip.** Your hand could strike the tripod or tripod collar foot, causing injury.

 **Before handling the camera, fully tighten or loosen the tripod collar lock screw according to whether the camera will be used in a fixed orientation or rotated.** If the screw is only partially tightened, the camera may move unexpectedly, causing injury.

*For Customers in the U. S. A.*

**Tested To Comply With FCC Standards  
FOR HOME OR OFFICE USE**

**FCC Statement:** This device complies with Part 15 of the FCC Rules. Operation is subject to the following two conditions: (1) This device may not cause harmful interference, and (2) this device must accept any interference received, including interference that may cause undesired operation.

**CAUTION:** This equipment has been tested and found to comply with the limits for a Class B digital device, pursuant to Part 15 of the FCC Rules. These limits are designed to provide reasonable protection against harmful interference in a residential installation. This equipment generates, uses, and can radiate radio frequency energy and, if not installed and used in accordance with the instructions, may cause harmful interference to radio communications. However, there is no guarantee that interference will not occur in a particular installation. If this equipment does cause harmful interference to radio or television reception, which can be determined by turning the equipment off and on, the user is encouraged to try to correct the interference by one or more of the following measures:

- Reorient or relocate the receiving antenna.
- Increase the separation between the equipment and receiver.



- Connect the equipment into an outlet on a circuit different from that to which the receiver is connected.
- Consult the dealer or an experienced radio/TV technician for help.
- You are cautioned that any changes or modifications not expressly approved in this manual could void the user's authority to operate the equipment.

**Notes on the Grant:** To comply with Part 15 of the FCC Rules, this product must be used with a Fujifilm-specified ferrite-core A/V cable, USB cable, and DC supply cord.

#### *For Customers in Canada*

#### **CAN ICES-3 (B)/NMB-3(B)**

**CAUTION:** This Class B digital apparatus complies with Canadian ICES-003.

#### **IMPORTANT SAFETY INSTRUCTIONS**

- Read these instructions.
- Keep these instructions.
- Heed all warnings.
- Follow all instructions.
- Do not use this apparatus near water (excluding waterproof products).
- Clean only with a dry cloth.
- Do not block any ventilation openings. Install in accordance with the manufacturer's instructions.
- Do not install near any heat sources such as ra-

diators, heat registers, stoves, or other apparatus (including amplifiers) that produce heat.

- Protect the power cord from being walked on or pinched particularly at plugs, convenience receptacles, and the point where they exit from the apparatus.
- Only use attachments/accessories specified by the manufacturer.
- Unplug this apparatus during lightning storms or when unused for long periods of time.
- Refer all servicing to qualified service personnel. Servicing is required when the apparatus has been damaged in any way, such as power supply cord or plug is damaged, liquid has been spilled or objects have fallen into the apparatus, the apparatus has been exposed to rain or moisture, does not operate normally, or has been dropped.

#### *Disposal of Electrical and Electronic Equipment in Private Households*

**In the European Union, Norway, Iceland and Liechtenstein:** This symbol on the product, or in the manual and in the warranty, and/or on its packaging indicates that this product shall not be treated as household waste. Instead it should be taken to an applicable collection point for the recycling of electrical and electronic equipment.



By ensuring this product is disposed of correctly, you will help prevent potential negative consequences to the environment and human health, which could otherwise be caused by inappropriate waste handling of this product.

The recycling of materials will help to conserve natural resources. For more detailed information about recycling this product, please contact your local city office, your household waste disposal service or the shop where you purchased the product.

**In Countries Outside the European Union, Norway, Iceland and Liechtenstein:** If you wish to discard this product, including the batteries or accumulators, please contact your local authorities and ask for the correct way of disposal.

#### **Australian RCM**



## Before Using This Product

Some lens features are not available with older versions of the camera firmware. Be sure to update the camera firmware to the latest version. Instructions on viewing the camera firmware version and updating camera firmware are available from the following website:

*[http://www.fujifilm.com/support/digital\\_cameras/software/#firmware](http://www.fujifilm.com/support/digital_cameras/software/#firmware)*

If you do not have access to a computer, support is available from the local distributor listed in the "FUJIFILM Worldwide Network" material provided with your camera.

## Product Care

- When using a lens hood, do not pick up or hold the camera using only the hood.
- Keep the lens signal contacts clean.
- Use a blower to remove dust and lint from the glass surfaces of the lens or filter. To remove

smudges and fingerprints, apply a small amount of lens cleaner to a soft, clean cotton cloth or lens-cleaning tissue and clean from the center outwards using a circular motion, taking care not to leave smears or touch the glass with your fingers.

- Never use organic solvents such as paint thinner or benzene to clean the lens.
- Attach the front and rear caps when the lens is not in use.
- Store the lens and filter in cool, dry locations to prevent mold and rust. Do not store in direct sunlight or with naphtha or camphor moth balls.
- Keep the lens dry. Rusting can cause irreparable damage. Wipe off rain and water droplets.
- Leaving the lens in extremely hot locations could cause damage or warping.
- Note that depending on the positions of the camera and tripod, the hand holding the camera grip may contact the tripod or tripod collar foot when the camera is rotated.

## Parts of the Lens

XF100-400mmF4.5-5.6 R LM OIS WR

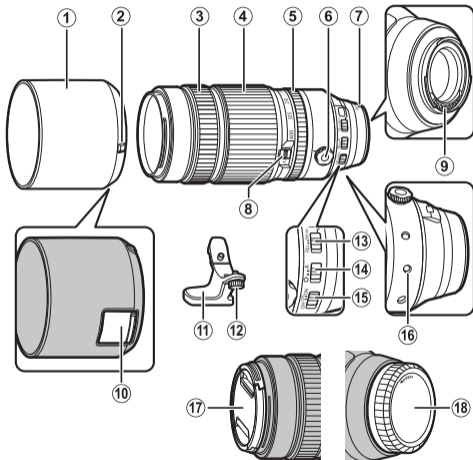

- ① Lens hood
- ② Hood latch release
- ③ Focus ring
- ④ Zoom ring
- ⑤ Aperture ring
- ⑥ Tripod collar lock screw
- ⑦ Mounting marks (focal length)
- ⑧ Zoom lock switch
- ⑨ Lens signal contacts
- ⑩ Filter access port
- ⑪ Tripod collar foot
- ⑫ Tripod foot mounting screw
- ⑬ Focus range selector
- ⑭ Aperture lock switch
- ⑮ O.I.S. switch
- ⑯ Lens rotating position index
- ⑰ Front lens cap
- ⑱ Rear lens cap

◆ The lens mount includes a rubber ring to ensure that the lens remains dust- and splash-proof. The ring can be replaced for a fee at any FUJIFILM service center.

## Supplied Accessories

- Front lens cap
- Rear lens cap
- Lens hood
- Cloth wrapping
- Tripod collar foot

## Attaching the Lens

See the camera manual for information on attaching and removing lenses. Note that this product is not compatible with X mount film cameras.

## Removing the Caps

Remove the caps as shown.

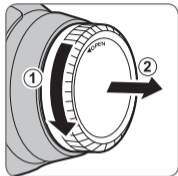
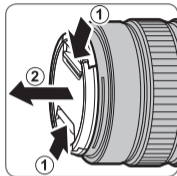

## Attaching the Hood

When attached, lens hoods reduce glare and protect the front lens element.

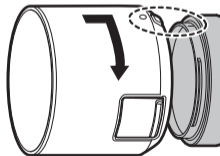

## Removing the Hood

To remove the hood, press and hold the hood latch release while rotating the hood counterclockwise.

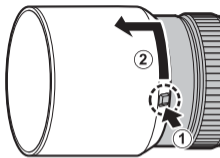

## The Focus Range Selector

Choose the focus range for autofocus. Choose **FULL** to focus on subjects at any distance, **5 m-∞** for faster focus when photographing subjects at distances of 5 m or more.



## The Polarizing Filter

To access the polarizing filter, open the filter access port cover.

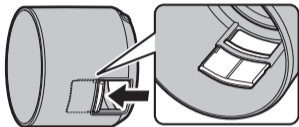

The filter can be rotated by inserting a finger through the access port.

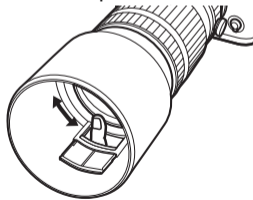



## The Tripod Collar Foot

To attach the tripod collar foot, align the mounting mark on the foot with the lens rotating position index and tighten the tripod foot mounting screw.

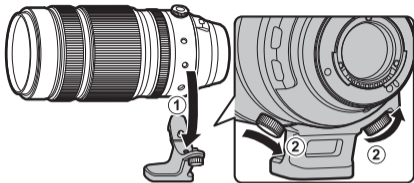

To rotate the camera from landscape to portrait orientation or back again without taking it off the tripod, loosen the tripod collar lock screw.

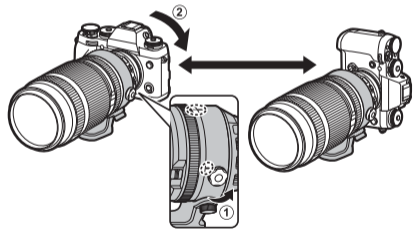

- ⓘ Tighten the screw securely to prevent the camera rotating unexpectedly.

## Zoom

Rotate the zoom ring left to zoom out, reducing magnification and increasing the area visible in the frame. Rotate the ring right to zoom in, increasing magnification so that the subject occupies more of the frame.

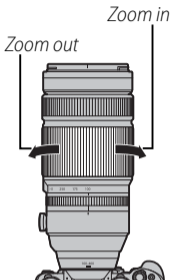

- ① Using the zoom ring while the lens is wet makes it easier for water to find its way inside the lens. Wipe any water from the lens before using the zoom ring.

## Optical Image Stabilization (OIS)

To use optical image stabilization, slide the O.I.S. switch to **ON**.

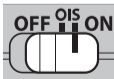

## Aperture

For auto aperture control, slide the aperture mode switch to **A**.



To adjust aperture manually, slide the switch to  and rotate the aperture ring. Rotate the ring left for wider apertures (lower f-numbers), right for smaller apertures (higher f-numbers).

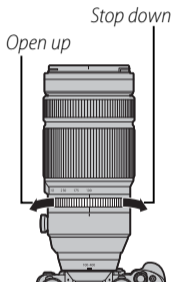

## Specifications

Type	<b>XF100-400mmF4.5-5.6 R LM OIS WR</b>
Lens construction	21 elements in 14 groups (includes 6 extra-low dispersion elements and 1 super extra-low dispersion element)
Focal length (35 mm format equivalent)	f=100–400 mm (152–609 mm)
Angle of view	16.2°–4.1°
Max. aperture	f/4.5–5.6
Min. aperture	f/22
Aperture control	
Number of blades	9 (rounded diaphragm opening)
Stop size	1/3 EV (15 stops)
Focus range	<b>Full:</b> 1.75 m–infinity <b>Restricted:</b> 5 m–infinity
Max. magnification	T: 0.19×
External dimensions: Diameter × Length* (approx.)	W: ø94.8 × 210.5 mm
* Distance from camera lens mount flange	T: ø94.8 × 270 mm
Weight* (approx.)	1375 g
*Excluding caps, hoods, and tripod collar feet	
Filter size	ø77 mm

① Improvements may result in unannounced changes to specifications and appearance.

① Owing to how this lens is constructed, the “Distance indicator” displayed by the camera may in some cases differ from the actual focus distance. Use the “Distance indicator” as a guide only.

◆ This lens uses linear motors to ensure fast and accurate auto focus while maintaining the highest image quality. When the camera is turned off, the lens is disconnected from the camera body, or the playback feature is turned on, there may be an audible sound and slight physical vibration due to the linear motor’s magnets being disengaged. This is perfectly normal and will not negatively affect image quality or lens performance.

富士フイルム株式会社

〒107-0052 東京都港区赤坂9丁目7番3号

**FUJIFILM Corporation**

7-3, AKASAKA 9-CHOME, MINATO-KU, TOKYO  
107-0052, JAPAN